

WIN CHANCE

Metal Co., Ltd.



2022

WE POWER GROWTH

INNOVATIVE
ERGONOMIC DESIGN
GREEN CONCEPT



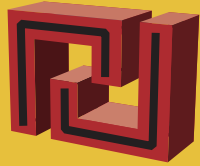

METAL HARDWARE
RATCHET BUCKLE TIE DOWN
CAM BUCKLE
SAFETY BUCKLE
CARABINER
SNAP HOOK
HOOK
TOOL LANYARD
FORGING
STAMPING, etc.

Win Chance Metal Co., Ltd.
No.15-10, Lane 142 Sec. 5 Chang Nan Rd., Chang Hua City 50088 Taiwan
T +886-4-7382460
F +886-4-7388180
E: info@winchance.tw
www.winchance.tw

ABOUT US

Win Chance Metal Co., Ltd. is a professional manufacturer of metal hardware, forging parts, wire-forming parts, stamped & pressed parts and all kinds of ratchet buckles & carabiners. We have earned an excellent reputation through more than 20 years of business experience.

In summary, a combination of experience and young enthusiastic staff ensure that we stay ahead of the competition in all that we strive to achieve and remain the best quality for our long-term goals.



ABOUT OUR SERVICE

- More Than 20 Years
- Professional Experiences
- Quality



Tool Lanyard



Cam Buckle



Ratchet Buckle



Forging

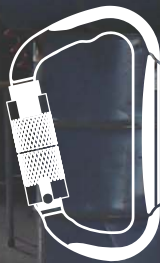

Carabiner



Snap Hook



Safety Buckle

TABLE OF

01 Ratchet Buckle

Detachable Series
Ergonomic Rubber Grip Series
Stainless Steel Series
A.B.S & Extendable Series
Traditional Series
Ratchet Tie Down Series

09 Stamping Parts Wire Forming Parts

Stamping Parts
Cam Buckle
S Hook
Ring
Buckle
Hook
J Hook
OEM Products
Fitting/Forging Parts

21 Fall Protection

Certificated Carabiner
Aluminum Carabiner
Steel Carabiner
Snap Hook
Swivel Connector

27 Tool Lanyard & Tether

Coil Tether
Bungee Rope
Bungee Rope - multi in one



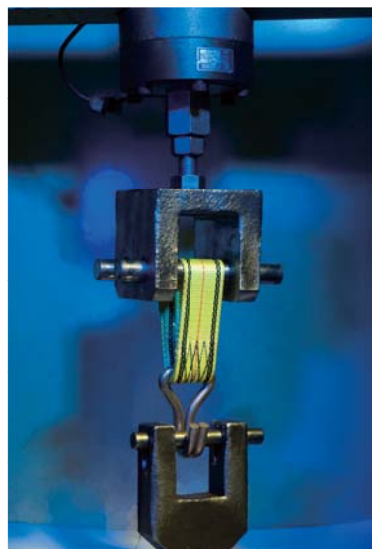

RATCHET BUCKLE

Detachable Series

Ideal for trucks and long-way deliveries.
 Meet environment protection and energy saving trendy.
 Prevent unauthority off-load - the ratchet is not able to be loosened without handle.
 Space saving and weight reduction.
 Freely matching handle and ratchet-body as packs.
 Taiwan Excellence rewarded.



2" Detachable Ratchet Buckle
R518901

Size: 2"/50mm
 B.S: 5000kg
 Finish: Zinc & Electric Black
 Removable handle type
 Ergonomic wide plastic grip

A:54mm B:98mm C:57mm D:211mm



2" Stainless Detachable Ratchet Buckle
R518902

Size: 2"/50mm
 B.S: 2500kg
 SUS 304
 Removable handle type
 Ergonomic wide plastic grip

A:54mm B:98mm C:57mm D:211mm



1.5" Detachable Ratchet Buckle
R438901

Size: 1.5"/35mm
 B.S: 3000kg
 Finish: Zinc & Electric Black
 Removable handle type
 Ergonomic wide plastic grip

A:42mm B:80mm C:59mm D:190mm



1.5" Stainless Detachable Ratchet Buckle
R438902

Size: 1.5"/35mm
 B.S: 1500kg
 SUS 304
 Removable handle type
 Ergonomic wide plastic grip

A:42mm B:80mm C:44mm D:175mm



1.5" Light duty Detachable Ratchet Buckle
R388901

Size: 1.5"/35mm
 B.S: 1800kg
 Finish: Zinc & Electric Black
 Removable handle type
 Ergonomic & anti-slip wide plastic grip

A:42mm B:80mm C:42mm D:172mm

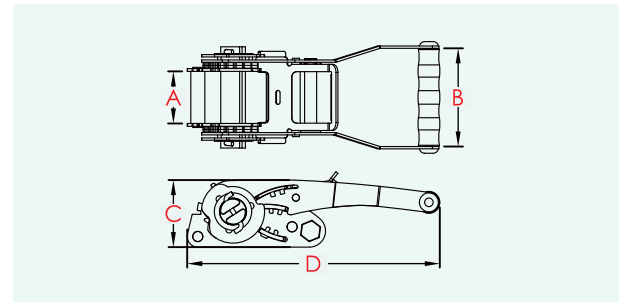

RATCHET BUCKLE

Ergonomic Rubber Grip Series

Heavy duty load securing preferred.
High visibility with colorful rubber handle.
Side rubber caps for better protection.



**2" Ergonomic Rubber Handle Ratchet Buckle
R510417**

Size: 2"/50mm
B.S: 5000kg
Finish: Zinc & Electric Black
Long lever type
Rubber grip

A:54mm B:107mm C:60mm D:223mm



**2" Ergonomic Middle Handle Ratchet Buckle
R510313**

Size: 2"/50mm
B.S: 5000kg
Finish: Zinc & Electric Black
Middle handle type
Rubber grip

A:54mm B:107mm C:54mm D:205mm



**1.5" Ergonomic Light Duty Ratchet Buckle
R380308**

Size: 1.5"/35mm
B.S: 1800kg
Finish: Zinc & Electric Black
Middle handle type
Rubber grip

A:42mm B:80mm C:40mm D:150mm



**1" Ergonomic Rubber Handle Ratchet Buckle
R280102**

Size: 1"/25mm
B.S: 1500kg
Finish: Zinc & Electric Black
Middle handle type
Rubber grip

A:30mm B:65mm C:41mm D:139mm



**1" Ergonomic Light Duty Ratchet Buckle
R240109**

Size: 1"/25mm
B.S: 800kg
Finish: Yellow Zinc & Electric Black
Rubber grip

A:27mm B:43mm C:41mm D:125mm

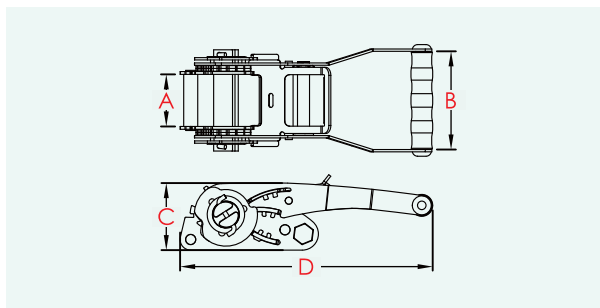

RATCHET BUCKLE

Stainless Steel Series

Ideal for commercial use.
 UV exposure tested - UV resistant and anti-rot
 Elegant outline and durable quality.



2" Stainless Long Lever Ratchet Buckle R5104 Series

Size: 2"/50mm
 B.S: 3000kg
 SUS 304 / SUS 316
 Long lever type
 Stainless steel grip

A:56mm B:98mm C:56mm D:229mm



2" Stainless Ratchet Buckle R5103 Series

Size: 2"/50mm
 B.S: 3000kg
 SUS 304 / SUS 316
 Middle handle type
 Stainless steel grip

A:56mm B:98mm C:60mm D:197mm



2" Stainless Light Duty Ratchet Buckle R510312

Size: 2"/50mm
 B.S: 1200kg
 SUS 304 / SUS 316
 Middle handle type
 Stainless steel grip

A:52mm B:82mm C:40mm D:131mm



1.5" Middle Handle Stainless Ratchet Buckle R4303 Series

Size: 1.5"/35mm
 B.S: 1500kg
 SUS 304 / SUS 316
 Middle handle type
 Stainless steel grip

A:41mm B:56mm C:56mm D:235mm



1.5" Short Handle Stainless Ratchet Buckle R4302 series

Size: 1.5"/35mm
 B.S: 1500kg
 SUS 304 / SUS 316
 Short handle type
 Stainless steel grip

A:41mm B:56mm C:58mm D:153mm



1.5" Light Duty Stainless Ratchet Buckle R3803 Series

Size: 1.5"/35mm
 B.S: 1200kg
 SUS 304 / SUS 316
 Middle handle type
 Stainless steel grip

A:40mm B:66mm C:40mm D:134mm



1" Stainless Ratchet Buckle R2803 Series

Size: 1"/25mm
 B.S: 600kg
 SUS 304 / SUS 316
 Middle handle type
 Stainless steel grip

A:31mm B:57mm C:37mm D:131mm



1" Light Duty Stainless Ratchet Buckle R2401 Series

Size: 1"/25mm
 B.S: 400kg
 SUS 304 / SUS 316

A:27mm B:38mm C:41mm D:110mm

RATCHET BUCKLE

A.B.S & Extendable Series

Ideal for commercial use.
 Heavy duty load securing preferred.
 Made for diagonal lashing.
 Powerful working ability.
 Telescopic handle for better pre-tension.
 Built-in safety device for slow down the release during off-load.
 Ergonomic wide plastic grip for ease of operation.
 Taiwan Excellence rewarded.



3" A.B.S Ratchet Buckle
R760703

Size: 3"/75mm
 B.S: 10000kg
 Finish: Yellow Zinc & Electric Black
 Long lever type
 Steel grip
 A.B.S system

A:77mm B:112mm C:80mm D:320mm



2" A.B.S Ratchet Buckle
R510701

Size: 2"/50mm
 B.S: 5000kg
 Finish: Zinc & Electric Black
 Long lever type
 Ergonomic wide plastic grip
 A.B.S system

A:52mm B:98mm C:67mm D:252mm



2" Extendable A.B.S Ratchet Buckle
R510602

Size: 2"/50mm
 B.S: 5000kg
 Finish: Zinc & Electric Black
 Extendable handle type
 Aluminum grip
 A.B.S system

A:52mm B:98mm C:67mm D:274/332mm



2" Extendable Ratchet Buckle
R510601

Size: 2"/50mm
 B.S: 5000kg
 Finish: Zinc & Electric Black
 Extendable handle type
 Steel grip

A:54mm B:98mm C:56mm D:242/300mm

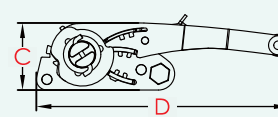
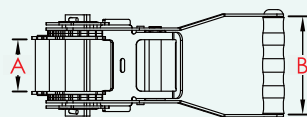

RATCHET BUCKLE Traditional Series

Transportation / off-road / cargo control / packing
Support various cargo control system



3" Long Handle Ratchet Buckle

R760401

Size: 3"/75mm
B.S: 10000kg
Finish: Yellow Zinc
Long handle type
Aluminum grip

A:80mm B:112mm C:77mm D:320mm



2" Long Handle Ratchet Buckle

R510407

Size: 2"/50mm
B.S: 5000kg
Finish: Yellow Zinc
Long handle type
Aluminum grip

A:56mm B:98mm C:56mm D:229mm



2" Long Handle Ratchet Buckle

R510403/ R510401

Size: 2"/50mm
B.S: 5000kg
Finish: Yellow Zinc /
Yellow Zinc & Electric Black
Long handle type
Plastic grip

A:56mm B:98mm C:56mm D:229mm



2" Middle Handle Ratchet Buckle

R510301

Size: 2"/50mm
B.S: 5000kg
Finish: Yellow Zinc
Middle handle type
Aluminum grip

A:56mm B:98mm C:60mm D:197mm



2" Straight Handle Ratchet Buckle

R510201

Size: 2"/50mm
B.S: 5000kg
Finish: Yellow Zinc
Straight handle type
Aluminum grip

A:56mm B:70mm C:58mm D:170mm



2" Light Duty Ratchet Buckle

R510311

Size: 2"/50mm
B.S: 2000kg
Finish: Yellow Zinc
Short handle type
Steel grip

A:54mm B:79mm C:40mm D:131mm



1.5" Long Handle Ratchet Buckle

R430401

Size: 1.5"/35mm
B.S: 3000kg
Finish: Yellow Zinc
Long handle type
Aluminum grip

A:41mm B:80mm C:56mm D:170mm



1.5" Straight Handle Ratchet Buckle

R430201/ R430203

Size: 1.5"/35mm
B.S: 3000kg
Finish: Yellow Zinc /
Yellow Zinc & Electric Black
Straight handle type
Aluminum grip

A:41mm B:56mm C:58mm D:153mm



1.5" Light Duty Ratchet Buckle

R380301

Size: 1.5"/35mm
 B.S: 1800kg
 Finish: Yellow Zinc
 Middle handle type
 Steel grip

A:42mm B:66mm C:40mm D:133mm



1" Middle Handle Ratchet Buckle

R280301

Size: 1"/25mm
 B.S: 1500kg
 Finish: Yellow Zinc
 Middle handle type
 Steel grip

A:31mm B:57mm C:37mm D:131mm



1" Once Forming Frame Ratchet Buckle

R280105

Size: 1"/25mm
 B.S: 1500kg
 Finish: Yellow Zinc
 Handle and side panel once forming type

A:30mm B:59mm C:41mm D:118mm



1" Light Duty Ratchet Buckle

R240103/ R240104

Size: 1"/25mm
 B.S: 800kg
 Finish: Yellow Zinc /
 Yellow Zinc & Electric Black

A:27mm B:38mm C:41mm D:110mm



3/4" Mini Ratchet Buckle

R180101

Size: 3/4"/19mm
 B.S: 300kg
 Finish: Zinc & Electric Black

A:20mm B:29mm C:30mm D:92mm



1/2" Mini Ratchet Buckle

R130101

Size: 1/2"/13mm
 B.S: 100kg
 Finish: Zinc & Electric Black

A:15mm B:24mm C:30mm D:83mm

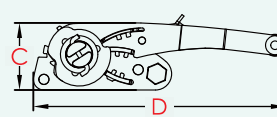
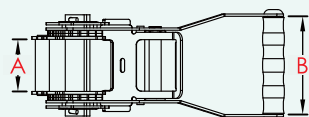

RATCHET BUCKLE

Ratchet Tie Down Series



2" Detachable Ratchet Tie Down T518901

Size: 2"/50mm
B.S: 5000kg
Finish: Zinc & Electric Black
Removable Handle
Ergonomic wide plastic grip
Includes of 8M weather-resistant Polyester webbing
Double J hook ends



2" A.B.S Ratchet Tie Down T510701

Size: 2"/50mm
B.S: 5000kg
Finish: Zinc & Electric Black
Built-in A.B.S system
Ergonomic wide plastic grip
Includes of 8M weather-resistant Polyester webbing
Double J hook ends



2" Extendable Handle Ratchet Tie Down T510601

Size: 2"/50mm
B.S: 5000kg
Finish: Zinc & Electric Black
Extendable handle type
Aluminum grip
Includes of 8M weather-resistant Polyester webbing
Double J hook ends



2" Standard Long Handle Ratchet Tie Down T510402

Size: 2"/50mm
B.S: 5000kg
Finish: Yellow Zinc
Long handle type
Aluminum grip
Includes of 8M weather-resistant Polyester webbing
Double J hook ends



2" Standard Long Handle Ratchet Tie Down T510403

Size: 2"/50mm
B.S: 5000kg
Finish: Yellow Zinc
Long handle type
Plastic grip
Includes of 8M weather-resistant Polyester webbing
Double J hook ends



2" Middle Handle Ratchet Tie Down T510302

Size: 2"/50mm
B.S: 5000kg
Finish: Yellow Zinc
Middle handle type
Aluminum grip
Includes of 8M weather-resistant Polyester webbing
Double J hook ends



2" Straight Handle Ratchet Tie Down T510201

Size: 2"/50mm
B.S: 5000kg
Finish: Yellow Zinc
Straight handle type
Aluminum grip
Includes of 8M weather-resistant Polyester webbing
Double J hook ends



2" Light Duty Ratchet Tie Down T510303

Size: 2"/50mm
B.S: 2000kg
Finish: Yellow Zinc
Short handle type
Steel grip
Includes of 8M weather-resistant Polyester webbing
Double J hook ends



1.5" Long Handle Ratchet Tie Down

T430301

Size: 1.5"/35mm
 B.S: 3000kg
 Finish: Yellow Zinc
 Long handle type
 Aluminum grip
 Includes of 4.5M weather-resistant
 Polyester webbing
 Double J hook ends



1.5" Straight Handle Ratchet Tie Down

T430203

Size: 1.5"/35mm
 B.S: 3000kg
 Finish: Yellow Zinc
 Straight Handle
 Aluminum grip
 Includes of 4.5M weather-resistant
 Polyester webbing
 Double J hook ends



1.5" Light Duty Ratchet Tie Down

T380303

Size: 1.5"/35mm
 B.S: 1800kg
 Finish: Yellow Zinc
 Middle handle
 Steel grip
 Includes of 4.5M weather-resistant
 Polyester webbing
 Double J hook ends



1" Middle Handle Ratchet Tie Down

T280305

Size: 1"/25mm
 B.S: 1500kg
 Finish: Yellow Zinc
 Middle handle type
 Steel grip
 Includes of 4M weather-resistant
 Polyester webbing
 Double J hook ends



1" Light Duty Ratchet Tie Down

T240101

Size: 1"/25mm
 B.S: 800kg
 Finish: Yellow Zinc
 Includes of 4M weather-resistant
 Polyester webbing
 Double J hook ends



3/4" Mini Ratchet Tie Down

T180109

Size: 3/4"/19mm
 B.S: 300kg
 Finish: Zinc & Electric Black
 Includes of 2M weather-resistant
 Polyester webbing
 PVC coating S hook ends



1/2" Mini Ratchet Tie Down

T130105

Size: 1/2"/13mm
 B.S: 100kg
 Finish: Zinc & Electric Black
 Includes of 2M weather-resistant
 Polyester webbing
 PVC coating S hook ends

Stamping Parts

Made by Precision Punching Machines in Win Chance



Flat Hook-01
F01 series

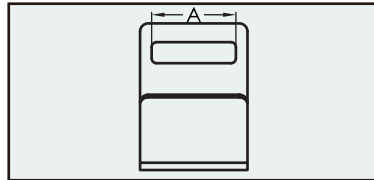

Material:Steel
Size:1"(25mm)/2"(46mm)



Flat Hook-02
F01 series

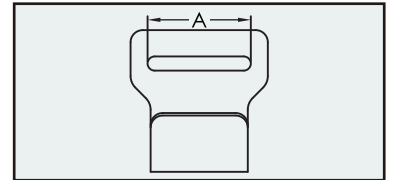

Material:Steel
Size:1.5"(38mm)/2"(51mm)



Flat/Twist Snap Hook
F04 series

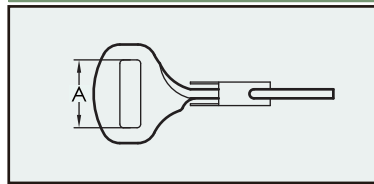

Material:Steel
Size:1"(25mm)/ 1.5"(38mm)/ 2"(51mm)



Flat Snap Hook
F02 series

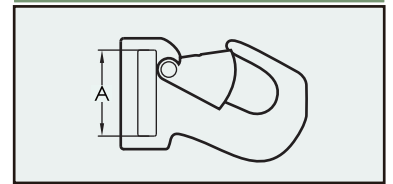

Material:Steel
Size:1"(25mm)/ 1.5"(38mm)/ 2"(51mm)



Delta Flat Hook
F44 series

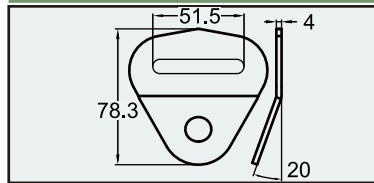

Material:Steel/ SUS304
Size:2"(51mm)



Buckle-01
F44 series

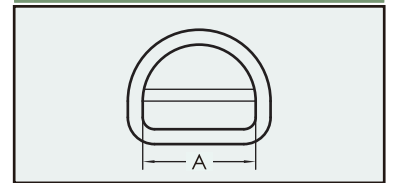

Material:Steel
Size:45mm/54mm



Buckle-02
F44 series

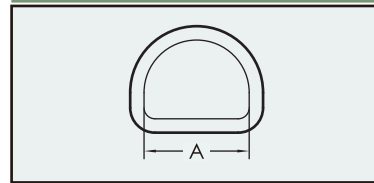

Material:Steel
Size:45mm/47mm/49mm/52mm



Buckle-03
F44 series

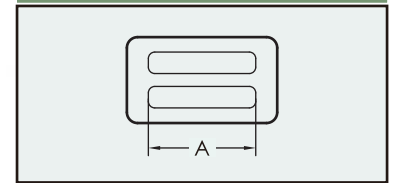

Material:Steel
Size:38mm/45mm/50mm/54mm



Buckle-04
F44 series

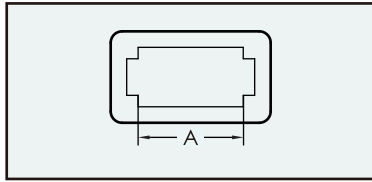

Material: Steel
Size: 42mm/45mm

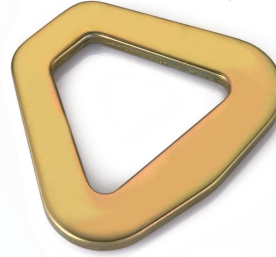

Buckle-05
F44 series

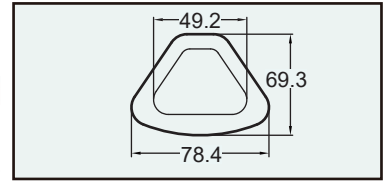

Material: Steel
Size: 49mm



Buckle-06
F44 series

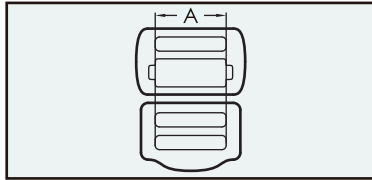

Material: Steel
Size: 45mm
One pair for harness



Harness Safety Buckle
K0601 series

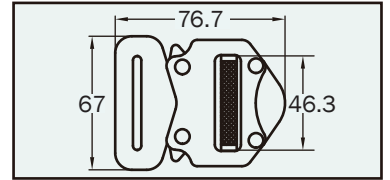

Min. Breaking Strength: 8kN/1750lbs
Aluminum Alloy
Safety Locking System
Webbing: 1 3/4" (45mm)



Harness Safety Buckle
K0602 series

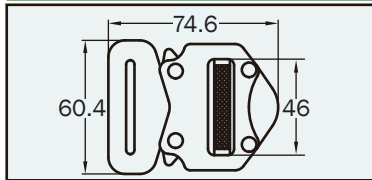

Min. Breaking Strength: 12kN/2500lbs
Alloy Steel
Safety Locking System
Webbing: 1 3/4" (45mm)



2" End Fitting
F010301

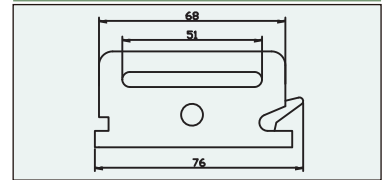

B.S: 1500kg
Finish: Yellow Zinc Plated

Cam Buckle

Best partner to use with webbing : Cam buckle tie down



1" Steel Cam Buckle

K010104-08

Size: 1"/25mm
 B.S: 500kg
 Finish: Electric black plated
 Optional Color Button
 Scratch proof pad

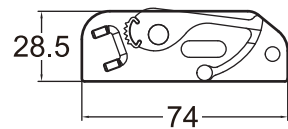
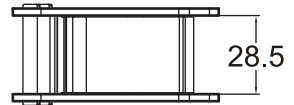

1" Cam Buckle

K010101

Size: 1"/25mm
 Zinc Alloy
 B.S: 250kg
 Finish: Electric black /
 Zinc plated

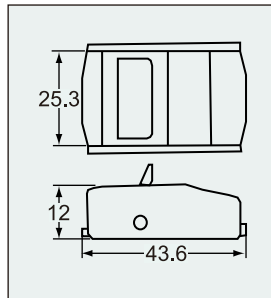

1" Cam Buckle

K010110

Size: 1"/25mm
 Zinc Alloy
 B.S: 350kg
 Finish: Electric black /
 Zinc plated

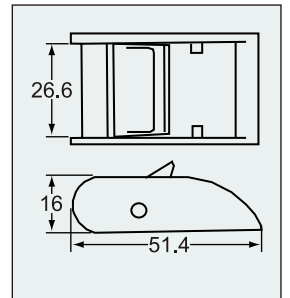

1.5" Cam Buckle

K010109

Size: 1.5"/35mm
 Zinc Alloy
 B.S: 680kg
 Finish: Electric black /
 Zinc plated

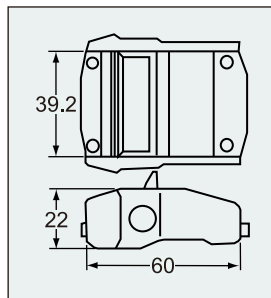

2" Cam Buckle

K010201

Size: 2"/50mm
 Cam: Zinc Alloy
 Body: Alloy Steel
 B.S: 1200kg
 Finish: Electric black /
 Zinc plated

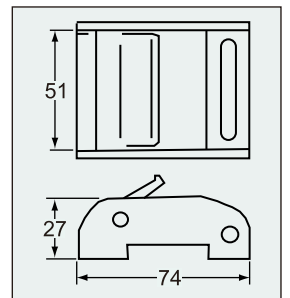

WIRE FORMING PARTS

S Hook



S Hook

S01 Series

Material: Steel/ SUS304/ SUS316
Plated/ Electric Black/ PVC Coating/ PE Coating/ Polished
Size: 25mm/ 27mm/ 30mm



S Hook

S06 Series

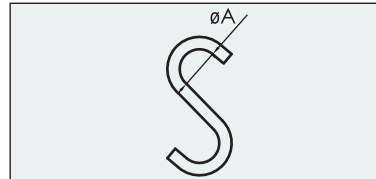

Material: Steel/ SUS304/ SUS316
Plated/ Electric Black/ PVC Coating/ Polished/
PE Coating
Size: 12mm/ 14mm/ 18mm/ 23mm/ 34.5mm



S Hook

S03 Series

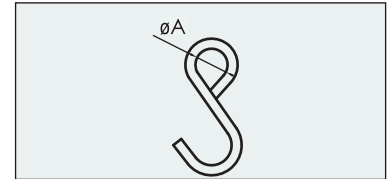

Material: Steel/ SUS304/ SUS316
Plated/ Electric Black/ PVC Coating/ Polished/
PE Coating
Size: 8mm/ 10mm/ 16mm/ 18mm/ 22mm/
23mm/ 25mm



S Hook with Spring

S01 Series

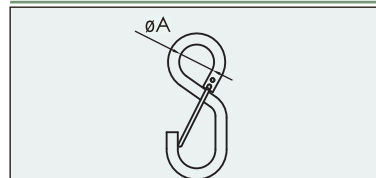

Material: Steel
Plated/ Electric Black/ PE Coating
Size: 25mm/ 27mm/ 31mm

WIRE FORMING PARTS

Ring

Practised molding team & precision punching machine
Your best partner for OEM/ODM project



D Ring
D01 Series

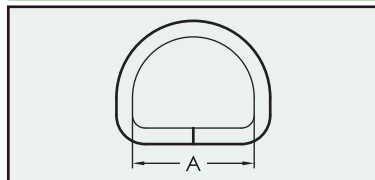

Material: Steel / Stainless Steel
Size: 25mm/38mm/40mm/51mm



D Ring with tube
D01 Series

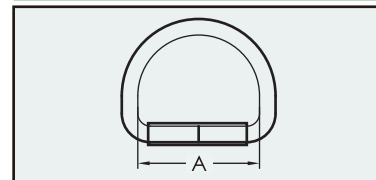

Material: Steel / Stainless Steel
Size: 25mm/38mm/40mm/51mm



Waisted Ring
H08 Series

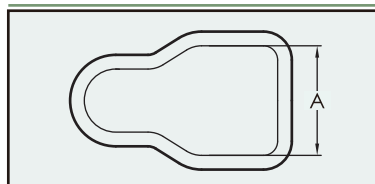

Material: Steel / Stainless Steel
Size: 1. $\phi 6.3 \times 28(A) \times 61\text{mm}$
2. $\phi 6.35 \times 29(A) \times 58.5\text{mm}$



O Ring
O01 Series

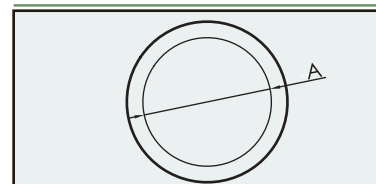

Material: Steel / Stainless Steel
Size: 15mm/20mm/25mm/30mm/
38mm/40mm/51mm/65mm/76mm



Triangle Ring
D05 Series

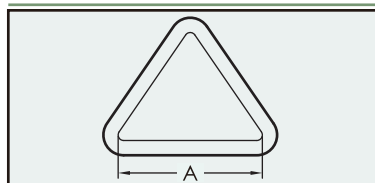

Material: Steel / Stainless Steel
Size: 26mm/53mm/70mm



Oval Ring
O07 Series

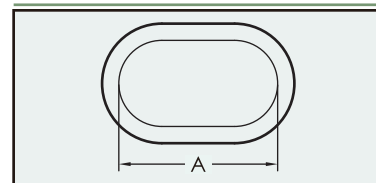

Material: Steel / Stainless Steel
Size: 28mm/51mm/55mm/60mm/
107mm



Rectangle Ring
D12 Series

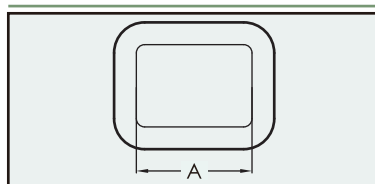

Material: Steel / Stainless Steel
Size: 13mm/19mm/25mm/38mm/
51mm/70mm

WIRE FORMING PARTS

Buckle



Wire Buckle
K05 Series

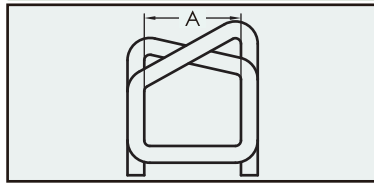

Material: Steel
Size: 13mm/16mm/19mm/27mm/
35mm

Lap Link
K02 Series

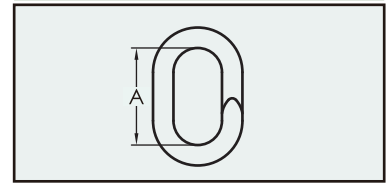

Material: Steel
Size: 19mm/25mm/31mm/38mm/
41mm/63mm

Eye Buckle/One Way Buckle
K04 Series

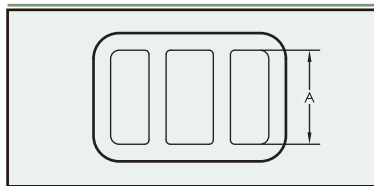

Material: Steel
Size: 45mm/55mm

Rave Hook
K04 Series

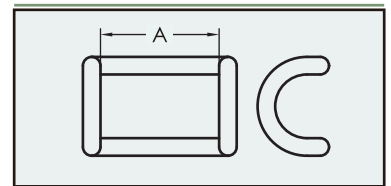

Material: Steel
Size: 1. $\phi 9.5 \times 51(A) \times 42\text{mm}$
2. $\phi 12 \times 51(A) \times 60\text{mm}$

Adjuster Buckle
K03 Series

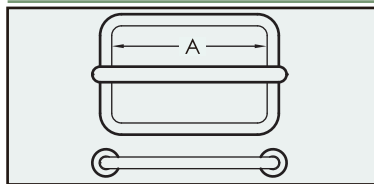

Material : SUS 304
Size: 25mm/40mm

Buckle with Anti-slip Adjuster
K03 Series

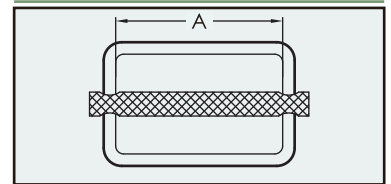

Material: Steel/SUS 304
Size: 25mm/41mm/51mm

Buckle with Dual Anti-slip Adjuster
K03 Series

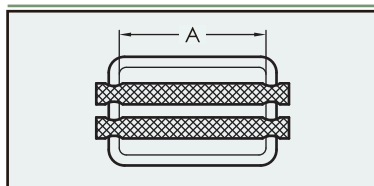

Material : SUS 304
Size: 31mm/41mm/51mm

WIRE FORMING PARTS

Hook



Bungee Hook-01
H03 Series



Material: Steel/SUS304
Size: 6.35x ϕ 1.8mmx51(L)mm
7.93x ϕ 2.8mmx71(L)mm
9.52x ϕ 3.0mmx66(L)mm

Bungee Hook-02
H03 Series

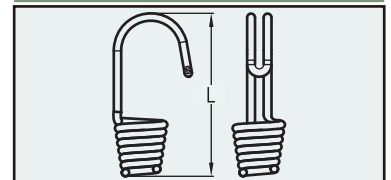

Material: Steel/SUS304

Single Stud Fitting
J16 Series

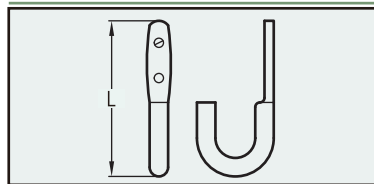

Material: Steel/SUS304
Size: ϕ 6.0mmx60(L)mm
 ϕ 9.5mmx94(L)mm

Wire Hook
With Eyelet / Without Eyelet
H08 Series

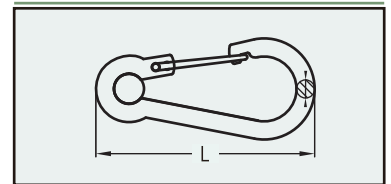

Material: Steel/SUS304
Size: ϕ 6mmxL62mm
 ϕ 8mmxL80mm

Wire Hook 6mm / 8mm
With Eyelet / Without Eyelet
H08 Series

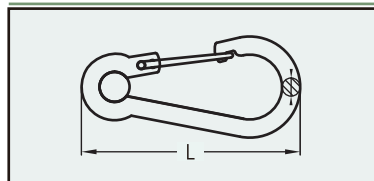

Material: Steel/SUS304
Size: ϕ 6mmxL62mm / ϕ 8mmxL80mm

Spring Hook
With Eyelet / Without Eyelet
S02 Series

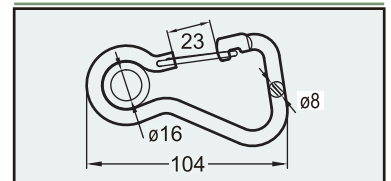

Material: Steel

Spring Hook
S02 Series

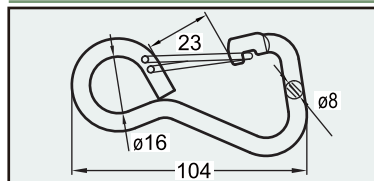

Material: Steel

Snap Hook
S11 Series

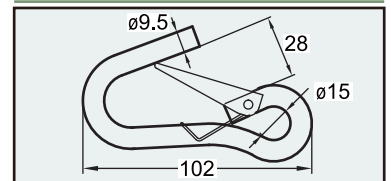

Material: Steel/ SUS304

**Quick Link
H07 Series**

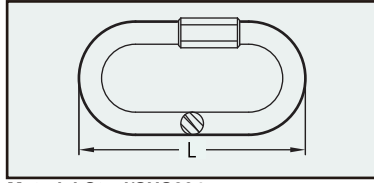

Material: Steel/SUS304
 Size: $\phi 3.5 \times 36.5(L)$ mm $\phi 8 \times 76(L)$ mm
 $\phi 4 \times 40(L)$ mm $\phi 9 \times 82(L)$ mm
 $\phi 5 \times 48(L)$ mm $\phi 10 \times 90(L)$ mm
 $\phi 6 \times 58(L)$ mm $\phi 12 \times 107(L)$ mm
 $\phi 7 \times 65(L)$ mm $\phi 14 \times 125(L)$ mm

Snap Hook with Eyelet/Without Eyelet

H08 Series

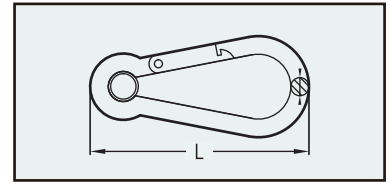

Material: Steel/SUS304
 Size: $\phi 4 \times 40(L)$ mm $\phi 10 \times 100(L)$ mm
 $\phi 5 \times 50(L)$ mm $\phi 11 \times 120(L)$ mm
 $\phi 6 \times 60(L)$ mm $\phi 12 \times 140(L)$ mm
 $\phi 7 \times 70(L)$ mm $\phi 13 \times 160(L)$ mm
 $\phi 8 \times 80(L)$ mm $\phi 14 \times 180(L)$ mm
 $\phi 9 \times 90(L)$ mm

**Wire Hook
With Eyelet / Without Eyelet
K08 Series**

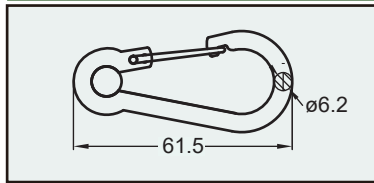

Material: Aluminum Alloy

WIRE FORMING PARTS

J Hook



Double J hook

J01 Series

Material: Steel/ SUS304/ SUS316
 Plated/ Electric Black/ PVC Coating/ Polished
 Size: 15mm/ 25mm/ 27mm/ 38mm/ 51mm/ 76mm

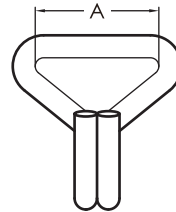

Welding Tube Single Hook

J04 Series

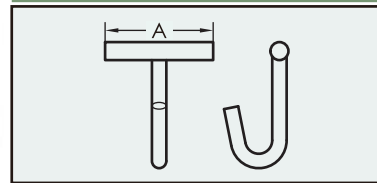

Material: Steel
 Plated/ Electric Black
 Size: 25mm/ 38mm/ 51mm



Welding Tube Profile Hook

J09 Series

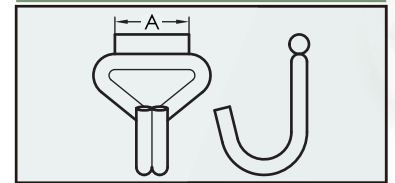

Material: Steel
 Plated/ Electric Black
 Size: 51mm/ 55mm



Eye Hook

J11 Series

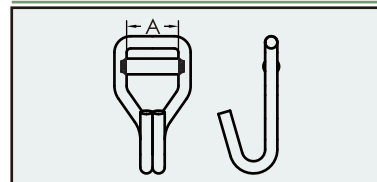

Material: Steel
 Plated/ Electric Black
 Size: 38mm/ 51mm



J Hook

J04 Series

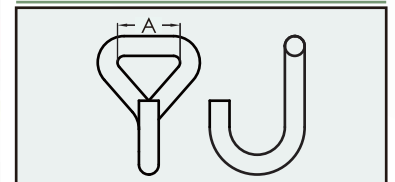

Material: Steel/ SUS304/ SUS316
 Plated/ Electric Black/ Polished
 Size: 38mm/ 47.5mm/ 51mm

Hook and Keeper

J07 Series

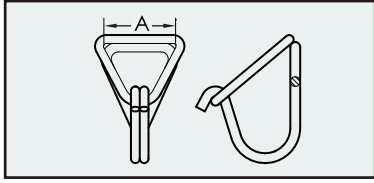

Material: Steel
Plated/ Electric Black
Size: 38mm/ 51mm



Finger Profile Hook

J06 Series

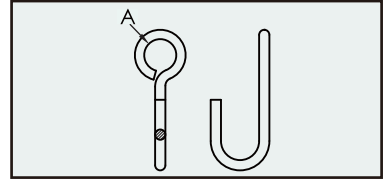

Material: Steel/ SUS304/ SUS316
Plated/ Electric Black/ PVC Coating/ Polished
Size: 25mm



OEM Products

Customization available
Taiwan-made good quality



Bolt/ Stud

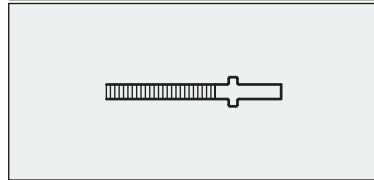

Material:Steel
Zinc Plated



Bolt/ Eyelet Screw

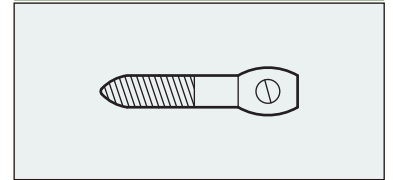

Material:Steel / SUS304
Zinc Plated / Polished



Bolt/ Eyelet Stud

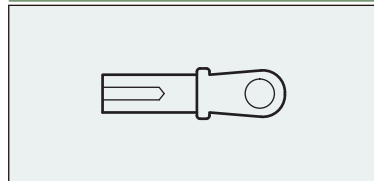

Material:Steel
Zinc Plated



Bolt/ Eyelet Stud

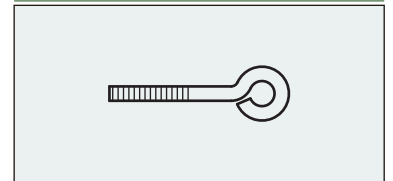

Material:Steel
Zinc Plated



Bolt/ Stud Hook

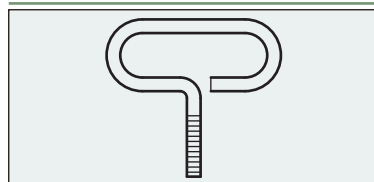

Material:Steel
Zinc Plated



Lock Pin

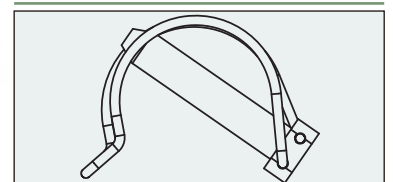

Material:Steel
Zinc Plated



Stud Hook With Spring

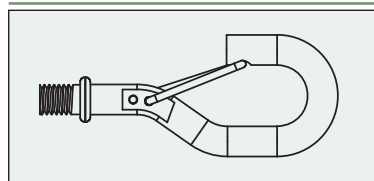

Material:Steel
Zinc Plated



Bolt/ Eyelet Stud

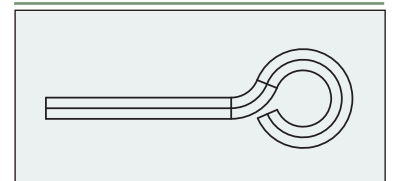

Material:Steel
Zinc Plated

Fitting/ Forging

Good partners for transportation



Double Stud Fitting
M071137

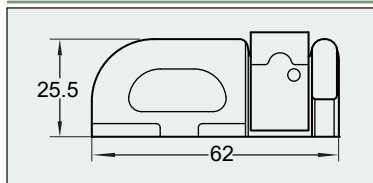

B.S: 2300kg
Finish: Zinc Plated



Double Stud Fitting with O ring
M071138

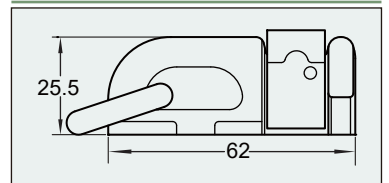

B.S: 2300kg
Finish: Zinc Plated



Single Stud Fitting
M071105

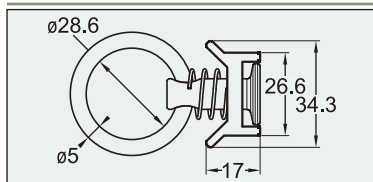

B.S: 1500kg
Finish: Body - Anodized
Ring - Zinc Plated



Forged Eyelet Stud
B01 Series

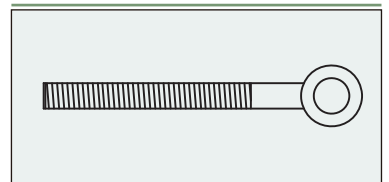

Material: Steel
Zinc/ Yellow Zinc Plated



Swivel Clip Hook
I0201 Series

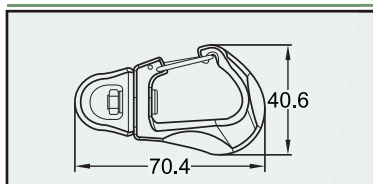

Material: Aluminum Alloy



Forged Snap Hook
E Series

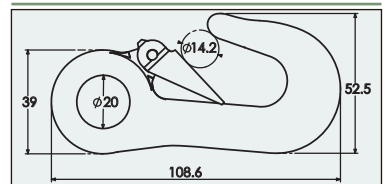

Material: Steel
Zinc/ Yellow Zinc Plated

Snap Hook & Carabiner Certificated Carabiner



C Carabiner
CBR-S-001

Alloy Steel
Screw Lock
Min. Breaking Strength:
23kN/5000lbs
EN362 Certificated

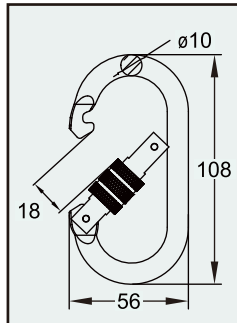

D1 Carabiner
CBRAD1-F-002

Forged Alloy Steel
Twist Steel Lock
Snag-Free Design
Min. Breaking Strength:
40kN/8900lbs
ANSI Certificated

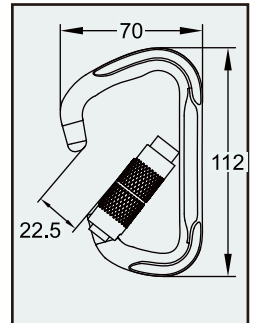

D Carabiner
CBRAD-ALF-002

Forged Aluminum Alloy
Twist Lock
Snag-free Design
Anodized
Min. Breaking Strength:
23kN/5000lbs
EN362 Certificated

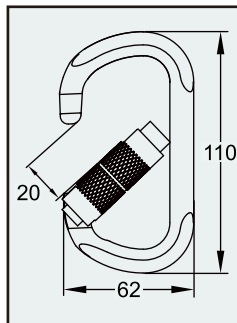

D1 Carabiner
CBRAD1-ALF-001

Forged Aluminum Alloy
Twist Lock
Snag-Free Design
Anodized
Min. Breaking Strength:
23kN/5000lbs
EN362 Certificated

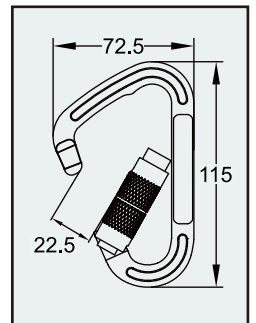

D1 Carabiner
CBRAD1-ALF-004

Forged Aluminum Alloy
Twist Lock
Snag-free Design
Anodized
Min. Breaking Strength:
23kN/5000lbs
EN362 Certificated

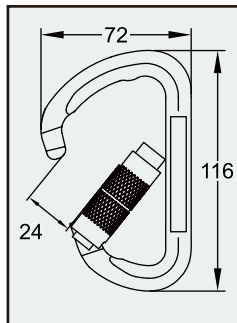

Twist Locking Snap Hook
RBH-AL-M-001

Forged Aluminum Alloy
Twist Lock
Snag-free Design
Anodized
Min. Breaking Strength:
23kN/5000lbs
EN362 Certificated

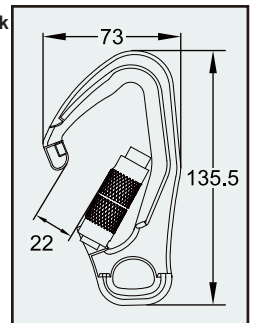

Self Locking Snap Hook
RBH-M-AL-003

Forged Aluminum Alloy
Anodized
Min. Breaking Strength:
35kN/7500lbs
EN362 Certificated

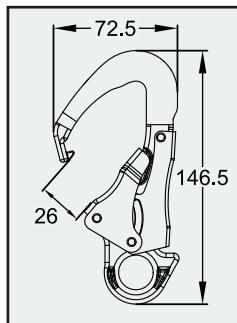

Snap Hook & Carabiner

Aluminum Carabiner



D Carabiner
C2102 series

Forged Aluminum Alloy
Twist Lock
Snag-free Design
Anodized
Min. Breaking Strength:
23kN/5000lbs

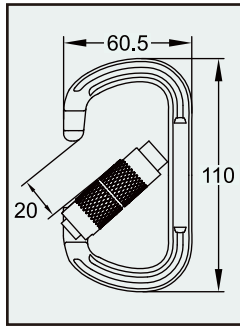

D Carabiner
C2101 series

Forged Aluminum Alloy
Screw Lock
Snag-free Design
Anodized
Min. Breaking Strength:
23kN/5000lbs

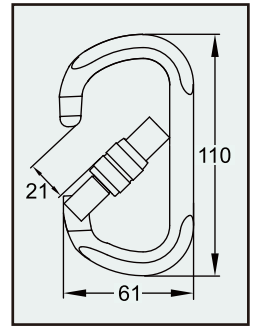

D1 Carabiner
C3102 series

Forged Aluminum Alloy
Twist Lock
Snag-free Design
Anodized
Min. Breaking Strength:
23kN/5000lbs

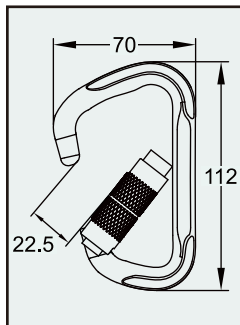

D1 Carabiner
C3101 series

Forged Aluminum Alloy
Screw Lock
Snag-free Design
Anodized
Min. Breaking Strength:
23kN/5000lbs

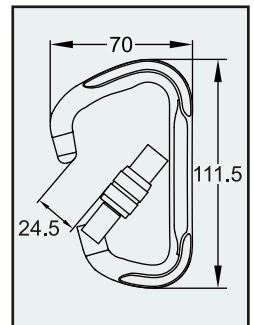

D1 Carabiner
C3102 series

Forged Aluminum Alloy
Twist Lock
Snag-free Design
Anodized
Min. Breaking Strength:
23kN/5000lbs

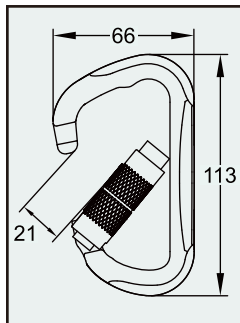

WAIST Carabiner
C4102 series

Forged Aluminum Alloy
Twist Lock
Snag-free Design
Anodized
Min. Breaking Strength:
23kN/5000lbs

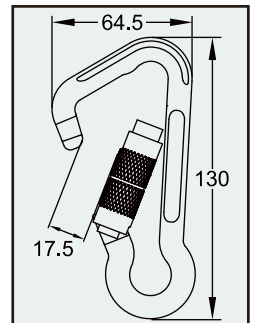

Quick Connector
C2103 series

Aluminum Alloy
Quick Lock
Snag-free Design
Anodized
Min. Breaking Strength:
9kN/2000lbs

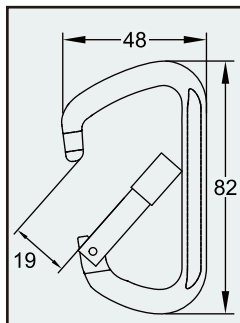

Carabiner
C2102 series

Aluminum Alloy
With/Without Captive Pin
Twist Lock
Snag-free Design
Anodized
Min. Breaking Strength:
9kN/2000lbs

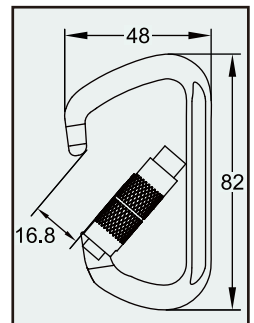

Snap Hook & Carabiner

Steel Carabiner

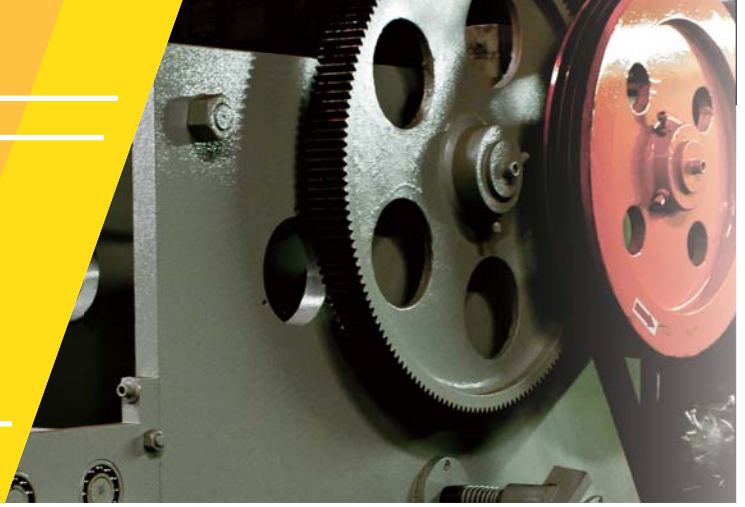

C Carabiner
C1203 series
 Alloy Steel
 One-way Lock
 Min. Breaking Strength:
 23kN/5000lbs

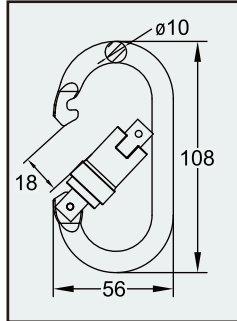

C Carabiner
C1303 series
 Stainless Steel(SUS 304)
 One-way Lock
 Min. Breaking Strength:
 10kN/2500lbs

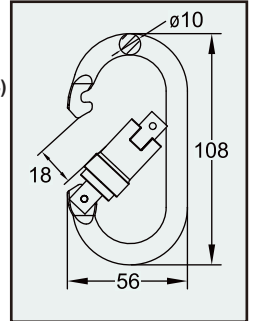

D Carabiner
C2203 series
 Alloy Steel
 One-way Lock
 Min. Breaking Strength:
 23kN/5000lbs

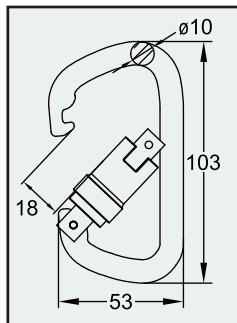

D Carabiner
C2303 series
 Stainless Steel(SUS 304)
 One-way Lock
 Min. Breaking Strength:
 10kN/2500lbs

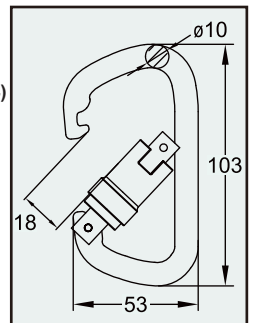

D Carabiner
C2202 series
 Forged Alloy Steel
 Twist Lock
 Min. Breaking Strength:
 23kN/5000lbs

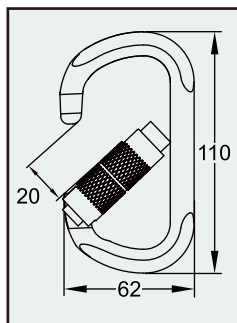

D1 Carabiner
C3203 series
 Alloy Steel
 One-way Lock
 Min. Breaking Strength:
 23kN/5000lbs

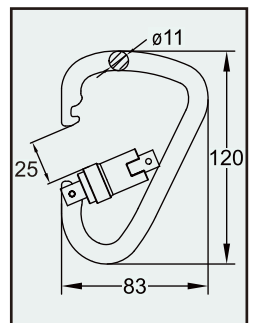

D1 Carabiner
C3202 series
 Alloy Steel
 Twist Lock
 Min. Breaking Strength:
 23kN/5000lbs

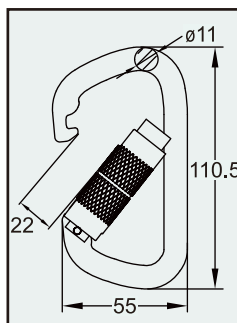

WAIST Carabiner
C4201 series
 Alloy Steel
 Screw Lock
 Min. Breaking Strength:
 23kN/5000lbs

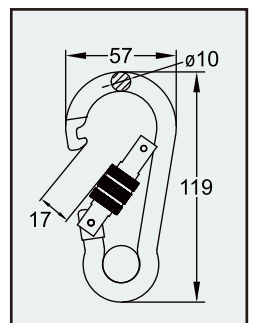



WAIST Carabiner
C4301 series
 Stainless Steel(SUS 304)
 Screw Lock
 Min. Breaking Strength:
 10kN/2500lbs

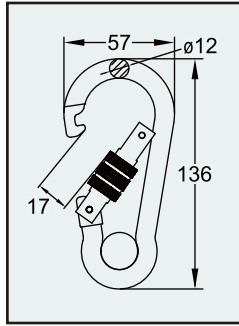

WAIST Carabiner
C4203 series
 Alloy Steel
 One-way Lock
 Min. Breaking Strength:
 23kN/5000lbs

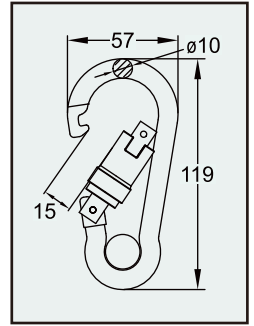

WIN CHANCE DESIGN CONCEPT

SHAPE

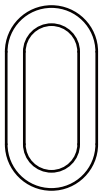

OVAL
 C Carabiner /
 Design for lower loads.

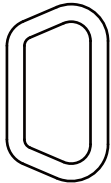

Regular D
 D Carabiner / Designed to
 orient the load in a
 predetermined direction on
 the connector's body.

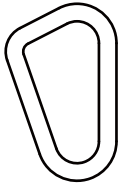

Asymmetrical D
 V or D1 Carabiner / V Shape is
 offset or curved to one side allows
 a climber to use the Munter Hitch
 for belaying without the rope
 getting stuck or jammed.

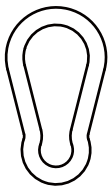

WAIST
 Waist Carabiner is to design to
 secure rope at bottom. To make
 sure the loading force is in same
 horizontal.



SPECIAL
 Captive Eye Carabiner / Connectors
 with complex shapes for a
 particular purpose; to be connected
 directly to a special anchor type.

GATE

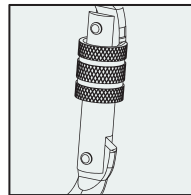

SCREW-LOCK

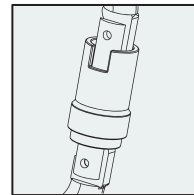

ONE-WAY LOCK

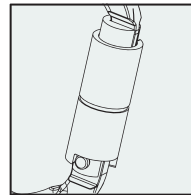

TWIST-LOCK

NOSE

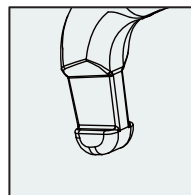

Snag Free

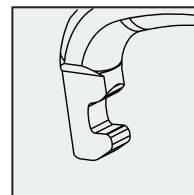

Regular

CAPTIVE PIN

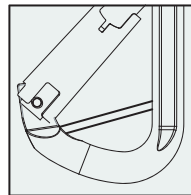

Snap Hook & Carabiner Snap Hook



**Self Locking Rebar Hook
A0102 series**

Alloy Steel
Min. Breaking Strength:
23kN/5000lbs

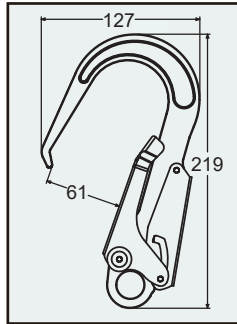

**Aluminum Rebar Hook
A0101 series**

Forged Aluminum Alloy
Min. Breaking Strength:
23kN/5000lbs

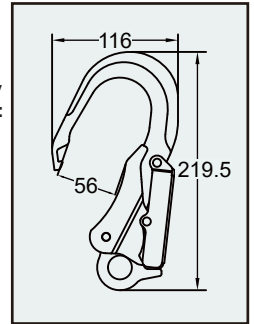

**Self Locking Rebar Hook
A0102 series**

Forged Alloy Steel
Min. Breaking Strength:
23kN/5000lbs

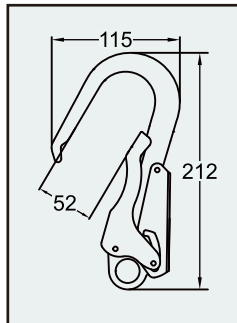

**Self Locking Snap Hook
A0202 series**

Alloy Steel
Min. Breaking Strength:
23kN/5000lbs

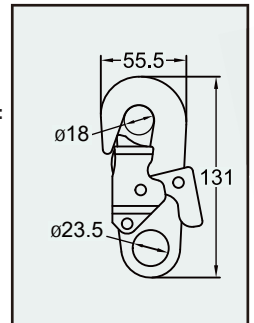

**Self Locking Snap Hook
A0302 series**

Alloy Steel
Min. Breaking Strength:
23kN/5000lbs

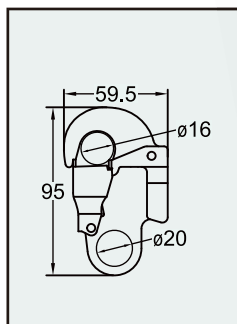

**Screw Locking Snap Hook
C5101 series**

Forged Aluminum Alloy
Screw Lock
Snag-free Design
Anodized Titanium
Min. Breaking Strength:
23kN/5000lbs

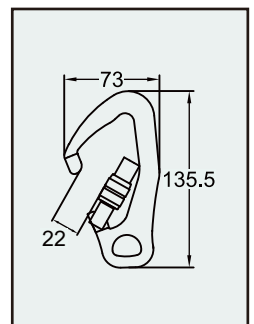

Snap Hook & Carabiner Swivel Connector

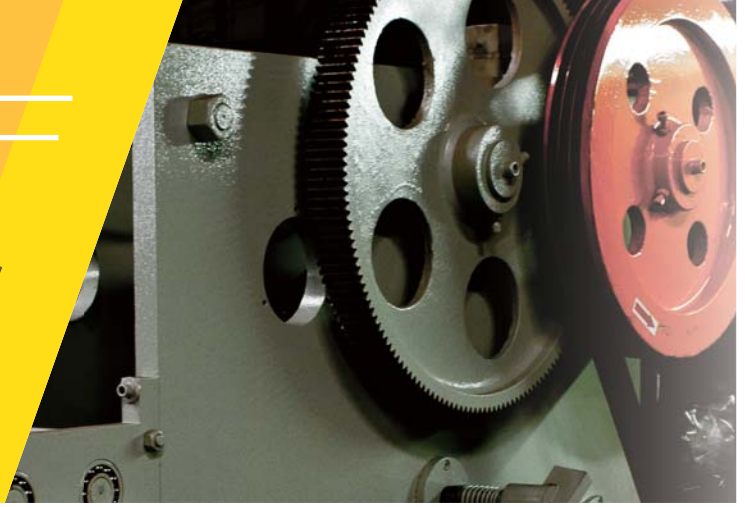

Swivel Connector - Large
I0201 series
 Forged Alloy Steel
 Yellow Zinc Plated / Chrome Plated
 Min. Breaking Strength: 40kN/8900lbs

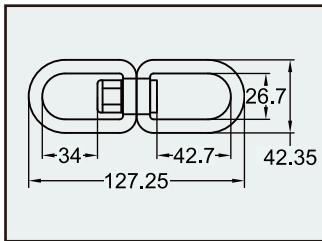

Swivel Connector - Medium
I0202 series
 Forged Alloy Steel
 Yellow Zinc Plated / Chrome Plated
 Min. Breaking Strength: 23kN/5000lbs

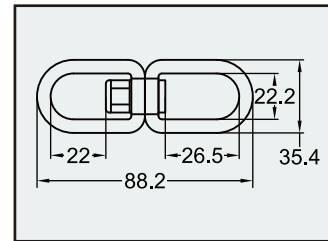

Aluminum Swivel Connector
I0102 series
 Forged Aluminum Alloy
 Anodized
 Min. Breaking Strength: 9kN/2000lbs

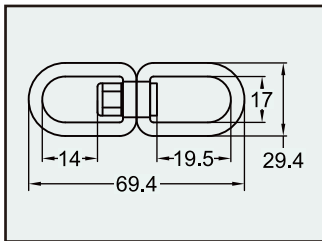

Swivel Combination
I0202 series
 Alloy Steel
 Chrome Plated
 Min. Breaking Strength: 23kN/5000lbs

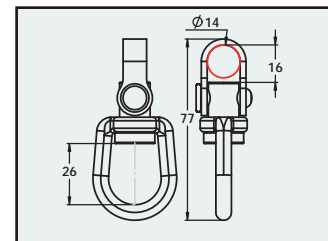

Swivel Connector
I0201 series
 Forged Aluminum Alloy
 Twist Lock
 Snag-free Design
 Anodized
 Min. Breaking Strength: 9kN/2000lbs

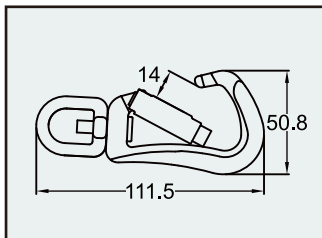

Pulley
I0201 series
 Aluminum Alloy
 Anodized
 Webbing width : 12mm
 Min. Breaking Strength: 600kg/1300lbs

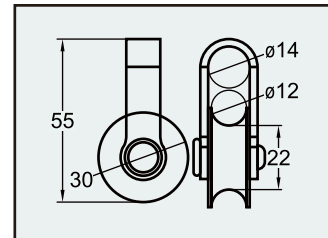

Tool Lanyard & Tether

Coil Tether

For personal belongings or light duty hand tools



Coil Tether

Q5201 Series

2mm Inner Wire
5mm PU
Max length 127cm
With WAIST Spring Hook x 2pcs(Steel/Aluminum)
S.W.L:5kg



Coil Tether

Q5203 Series

1.5mm Inner Wire
5mm PU
Max length 160cm
Swivel Tool Hook x 1pc(Steel/Aluminum)
WAIST Spring Hook x 1pc(Steel/Aluminum)
S.W.L:3kg



Coil Tether

Q4202 Series

1.2mm Inner Wire
4mm PU
Max length 160cm
With Swivel Tool Hook x 2pcs(Steel/Aluminum)
S.W.L:2kg



Coil Tether

Q4203 Series

1.2mm Inner Wire
4mm PU
Max length 160cm
Swivel Tool Hook x 1pc(Steel/Aluminum)
WAIST Spring Hook x 1pc(Steel/Aluminum)
S.W.L:3kg



Coil Tether

Q4201 Series

1.5mm Inner Wire
4mm PU
Max length 127cm
With WAIST Spring Hook x 2pcs(Steel/Aluminum)
S.W.L:3kg



Coil Tether

Q3203 Series

1.2mm Inner Wire
3mm PU
Max length 170cm
Swivel Tool Hook x 1pc(Steel/Aluminum)
WAIST Spring Hook x 1pc(Steel/Aluminum)
S.W.L:2kg



Coil Tether

Q3205 Series

1.2mm Inner Wire
3mm PU
Max length 60cm
Swivel Zinc Hook x 1pc
Loop Tail x 1pc
S.W.L:1.5kg

Tool Lanyard & Tether Bungee Rope

Electric-powered hand tool / air tool or heavy duty tools purpose



Bungee Rope

Q1103 Series

Length:63cm/141cm(Max.)
Aluminum Swivel Twist Lock Carabiner x 1pc
Aluminum Twist Lock Carabiner x 1pc
S.W.L:10kg



Bungee Rope

Q1103 Series

Length:63cm/141cm(Max.)
Aluminum WAIST Spring Hook x 1pc
Aluminum Swivel Twist Lock Carabiner x 1pc
S.W.L:10kg



Bungee Rope

Q1103 Series

Length:63cm/141cm(Max.)
Aluminum WAIST Spring Hook x 1pc
Aluminum Swivel Tool Hook x 1pc
S.W.L:10kg



Bungee Rope

Q1103 Series

Length:63cm/141cm(Max.)
Steel WAIST Spring Hook x 1pc
Steel Swivel Tool Hook x 1pc
S.W.L:10kg



Bungee Rope

Q1103 Series

Length:61cm/144cm(Max.)
Stainless Swivel Trigger Hook x 1pc
Aluminum WAIST Spring Hook x 1pc
S.W.L:10kg



Bungee Rope

Q1104 Series

Length:78cm/161cm(Max.)
Aluminum Twist Lock Carabiner x 1pc
Loop Tail x 1pc
S.W.L:10kg



Bungee Rope

Q1105 Series

Length:76cm/150cm(Max.)
Steel Swivel Snap Shackle Round Head x 1pc
Loop Tail x 1pc
S.W.L:10kg



Bungee Rope

Q1105 Series

Length:76cm/150cm(Max.)
Stainless Swivel Trigger Hook x 1pc
Loop Tail x 1pc
S.W.L:5kg



Bungee Rope

Q1105 Series

Length:76cm/150cm(Max.)
Aluminum Swivel Clip Hook x 1 pc
Loop Tail x 1pc
S.W.L:10kg



Bungee Rope

Q1104 Series

Length:76cm/150cm(Max.)
Aluminum WAIST Spring Hook x 1pc
Loop Tail x 1pc
S.W.L:5kg

Tool Lanyard & Tether Bungee Rope – multi in one

Electric-powered hand tool / air tool or heavy duty tools purpose



Multiple Bungee Rope

Q1108 Series

Length:63cm/141cm(Max.)
Aluminum Swivel Twist Lock Carabiner x 2pcs
Aluminum Twist Lock Carabiner x 1pc



Multiple Bungee Rope

Q1108 Series

Length:63cm/141cm(Max.)
Aluminum WAIST Spring Hook x 1pc
Aluminum Swivel Tool Hook x 2pcs



Multiple Bungee Rope

Q1112 Series

Length:63cm/141cm(Max.)
Aluminum Swivel Twist Lock Carabiner x 3pcs
Aluminum Twist Lock Carabiner x 1pc



Multiple Bungee Rope

Q1112 Series

Length:63cm/141cm(Max.)
Aluminum WAIST Spring Hook x 1pc
Aluminum Swivel Tool Hook x 3pcs

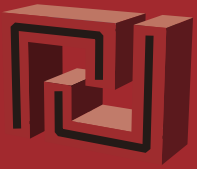

OEM FORGING

-Forged by professional equipment

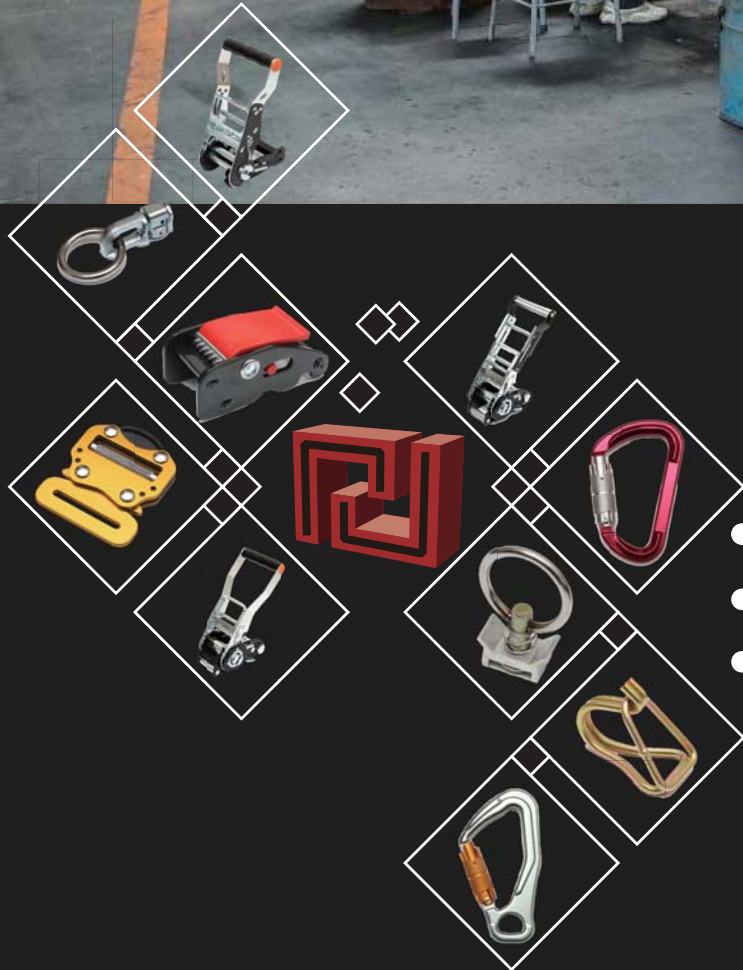

- Customization available
- Taiwan-made good quality
- Continuous line service:
raw material, tooling, forging, tumbling, vibration, and so on