

120  Years

博哈-來自西班牙第一品牌屋瓦

TEJAS BORJA
Since 1899

12C  Years



超過一世紀的瓦廠

100%西班牙在地生產製造

TEJAS BORJA 屋瓦原料~陶土，是取自於自有的礦場。從原料的精挑細選到品質的精益求精一百多年來TEJAS BORJA 堅持提供客戶最優質的陶瓷屋瓦。

自1899年起至今歷經五代，BORJA 家族未改初衷，熱情持續不減，努力創造獨特並且經得起時間考驗的產品，每片瓦都是出自地中海地區精挑細選的陶土燒製而成。TEJAS BORJA 超過一百年仍屹立不搖便是對專業品質保證的最佳註解。



THE [®]EVOLUTION

of the ceramic tile sector

2

連不易察覺的細微之處都會在意，才能創造產品的獨特性
TEJAS BORJA博哈屋瓦 深知所製造的不僅是屋頂的瓦片而已
更是給您的家人及夢想之屋，提供最完善的長久保護
就是因為有這樣的製瓦哲學，才能讓 TEJAS BORJA 卓然而立
既然自許為瓦界的先驅和專家，TEJAS BORJA 夙夜匪懈
一邁向前追求卓越。



TEJAS BORJA
Unique since 1899

Francisco Ramón Borja

產品國際化成功獎

由西班牙政府商業廳頒發
肯定TEJAS BORJA成功將產品
推向海外69個國家。



2012愛爾發創新獎

由西班牙陶瓷玻璃產業協會頒
發給 TEJAS BORJA，肯定
Skin-Ker 產品設計應用於建築
物外牆而兼具包覆美觀及通風
效果。



2013年最佳陶瓦建築獎

肯定 TEJAS BORJA 成功修復
重建800年巴塞隆納亞拉崗時
期古蹟。



*The Royal Institute of
the Architects of Ireland*

2014年度最佳外觀建材獎

由愛爾蘭都柏林國際建材展主
辦單位頒發給 TEJAS BORJA
的 F10 瓦型。



FLAT 平板瓦系列

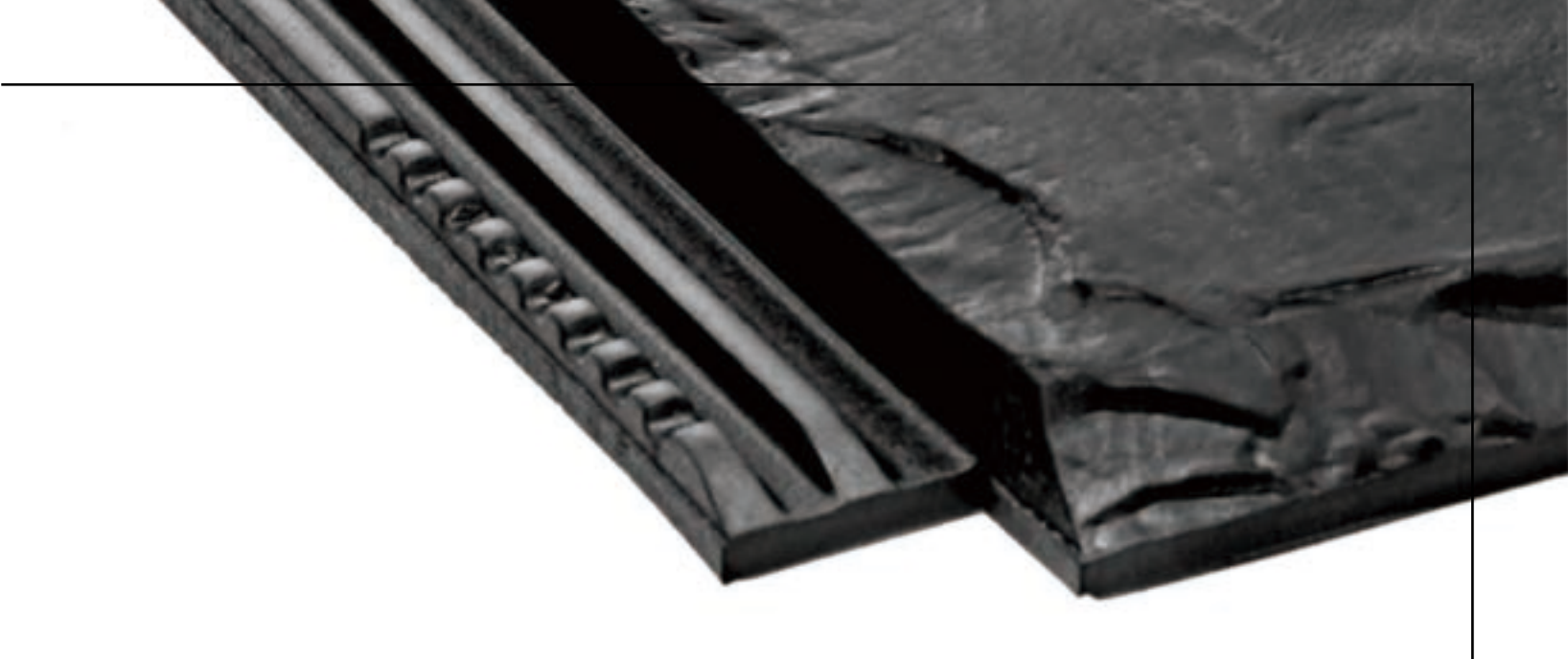

FLAT 平板瓦系列



FLAT-5XL®

Flat-5XL
是全世界最大尺寸的
陶瓦，也是在舊產業
發展創新思維的典範

FLAT-10 Tech TBAF-10

Flat-10
是最新世代的陶瓦
重量更輕，強度更好
質地更細緻，不僅用
於屋頂，也可以當
外牆陶板

博哈用最先進的生產
技術，再造馬賽瓦的
新世代，此瓦型至今
流行不墜，它仍是全
世界各地最廣受歡迎
的瓦型

TBAF-12

TBAF-12馬賽瓦
馬賽瓦兩道滑順的排
水溝槽型式，很具傳
統古典風格，而且廣
受世界各地不同氣候
地區及文化的人們喜
愛。



reddot award 2019
winner 德國紅點設計獎

世界最大片的陶土瓦
高覆蓋效率 (5 片/米平方米)
多種色彩及表面紋路可供選擇
(BorjaJET 絕色系列)



® TRADE MODEL
> Klinker



超高平坦度



抗嚴峻高山氣候



上下交疊極小化
僅45mm



高抗折力

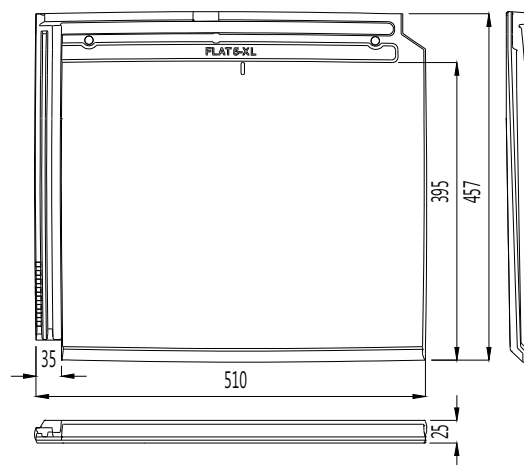

實際尺寸	457 mm x 510 mm
最低斜度建議	35% - 19° (*)
每片重量	6.55 Kg./片
平方公尺m ² /片	5.5 片
橫向每米片數	2 片
有效寬度	476 mm
有效長度	340-385 mm
棧板包裝	(G1) 152 片 / 990 Kg.
每捆片數	2 片



約當數值：如果使用掛瓦條安裝，則瓦片的有效長度應依掛瓦條間距計算。
依據EN1024規定瓦片尺寸公差允值為±2%

環境區分（低風災地區）屋頂斜面長度在6.5m以內者，建議用交疊（交釘）方式安裝，並且建議使用防水毯，掛瓦條間距由上至下皆為340mm。

另請參考EN法規規定，在不同的風力環境、屋頂斜度及長度設計下，使用正確的安裝施作

單色系列



硯石黑

Ceramic 板岩系列



橘彩石



金風石



雁灰(玄青岩)

Ceramic 雨花石系列



青灰石



金色大地

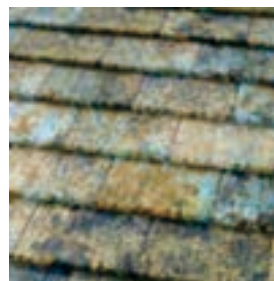

孔雀藍

Ceramic 古锈系列

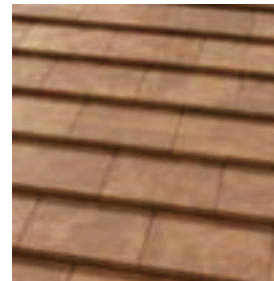

古銅

Ceramic 工業風系列



淡墨

Ceramic 大理石系列



黑金峰

Ceramic 復古系列



彤岩

附註：
博哈絕色系列FLAT-5XL是依訂單生產。
所有FLAT-5XL產品均為單面上色
硯石黑、板岩系列、雨花石系列的表面
均為仿天然石紋。

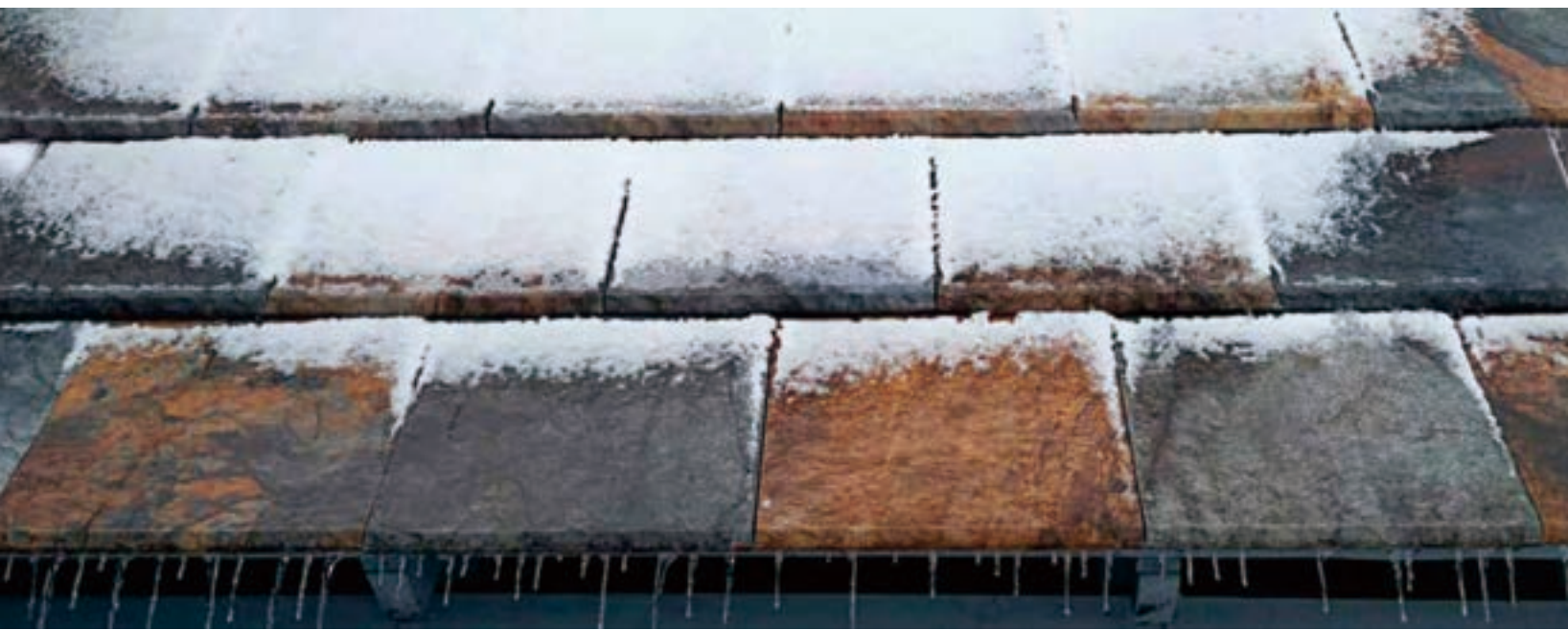

左右互鎖溝槽深度密合
 加大尺寸，每平方米9.9片
 BorjaJET 絕色系列花色

輕量化



> Klinker



超高平坦度



抗嚴峻高山氣候



上下交疊極小化
 僅35mm

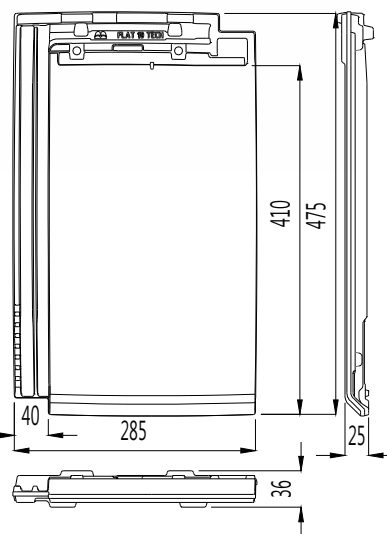

實際尺寸	475 mm x 285 mm
最低斜度建議	35% - 19° (*)
每片重量	3.5 Kg./片
平方公尺m ² / 片	9.9 片
橫向每米片數	4 片
有效寬度	250 mm
有效長度	365-400 mm
棧板包裝	(T1) 240 片 / 850 Kg. (T2) 320 片 / 1.130 Kg.
每捆片數	5 片 / 6 片



約當數值：如果使用掛瓦條安裝，則瓦片的有效長度應依掛瓦條間距計算。
 依據EN1024規定瓦片尺寸公差允值為±2%
 法國標準協會認證是針對黏土燒制的陶制建材做破壞性測試，包括結構缺失幾何數值差異、抗折強度、抗滲透性及耐寒等。
 環境區分（低風災地區）屋頂斜面長度在6.5m以內者，建議用交疊（交釘）方式安裝，並且建議使用防水毯，掛瓦條間距由上至下皆為340mm。
 另請參考EN13602法規規定，在不同的風力環境、屋頂斜度及長度設計下使用正確的安裝施作

單色系列



石墨黑

咖啡



鐵灰

碳黑



硯石黑

極地白

大地色系列



百年紅

歲月紅



Ceramic 板岩系列



橘彩石

金風石

Ceramic 木紋系列



橡木紋

西洋杉

Ceramic 工業風系列



淡墨

Ceramic 古銹系列

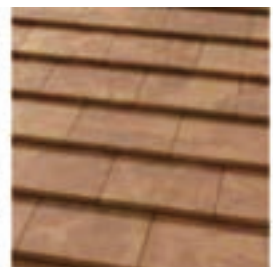

古銅

Ceramic 復古系列



彤岩

附註: 硯石黑、板岩系列、木紋系列的表面均為仿天然紋路。所有Flat-10產品均為單面上色。



> Klinker



系統式安裝



抗嚴峻高山氣候



上下交疊極小化
僅40mm

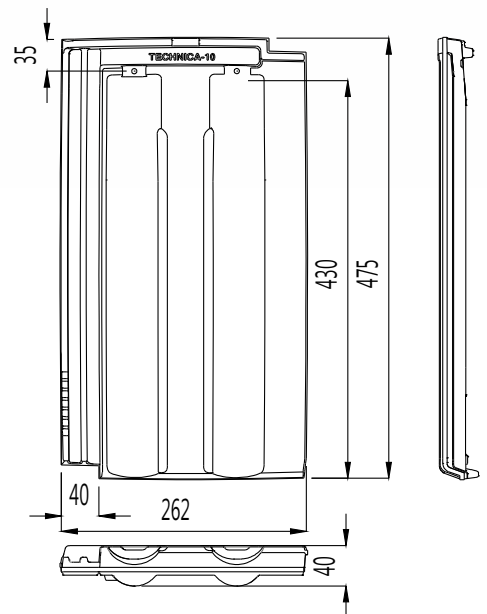

實際尺寸	475 mm x 262 mm
最低斜度建議	35% - 19° (*)
每片重量	3.15 Kg./片
平方公尺m ² / 片	10.7 片
橫向每米片數	4.5 片
有效寬度	218 mm
有效長度	370-410 mm
棧板包裝	(TB) 320 片 / 1.070 Kg. (TC) 240 片 / 805 Kg.
每捆片數	5 片



約當數值：如果使用掛瓦條安裝，則瓦片的有效長度應依掛瓦條間距計算。依據EN1024規定瓦片尺寸公差允值為±2%
法國標準協會認證是針對黏土燒制的陶制建材做破壞性測試，包括結構缺失幾何數值差異、抗折強度、抗滲透性及耐寒等。
環境區分（低風災地區）屋頂斜面長度在6.5m以內者，建議用交疊（交釘）方式安裝，並且建議使用防水毯，掛瓦條間距由上至下皆為340mm。
另請參考EN136020法規規定，在不同的風力環境、屋頂斜度及長度設計下使用正確的安裝施作

☞ 單色系列



石墨黑

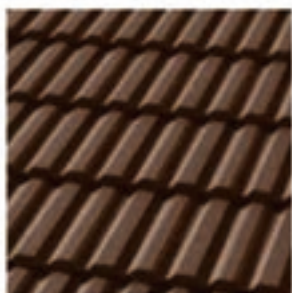

咖啡

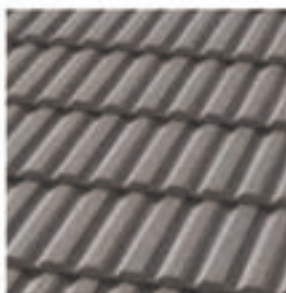

鐵灰

☞ 大地色系列

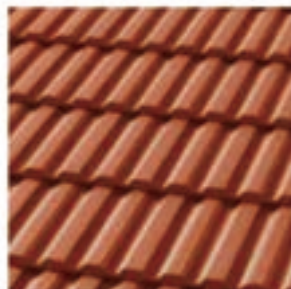

百年紅



歲月紅

附註: 所有TBAF-10產品均為單面上色。



流線型的雙溝槽
讓排水更順暢
舊屋頂翻修的最佳選擇



12



系統化安裝



最低斜度建議
35% - 19°



瓦片規格	
寬度	252 mm
長度	430 mm
重量	3.15 kg/片

安裝規範	
平方公尺m ² /片	12.3 片
瓦條間距	370 mm

大地色系列

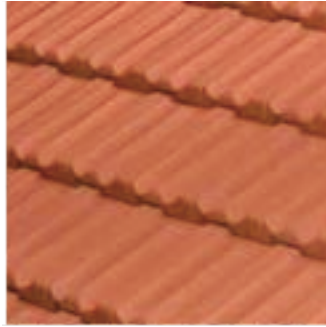

百年紅

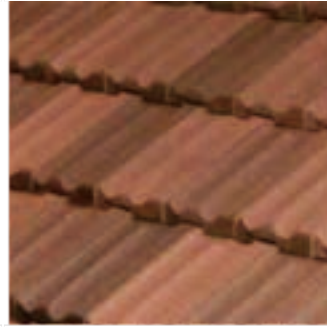

楓丹



丹影



金穗





FLAT 平板瓦系列

配件



F型脊瓦
42 x 30,5 x 9,7 cm.
2,5 Units/ml / 3,2 kg.
Max. Slope. 62%-31,5°



F型斜脊瓦頭
42,2 x 30,5 x 10 cm.
2,83 kg.



F型三通瓦
45,2 x 29,3 x 10 cm.
4,37 kg.



F型四通瓦
46 x 41,5 x 16,5 cm.
6,50 Kg.



F型脊瓦頭
8,5 x 28,5 x 12,5 cm.
2,65 kg.



低 100° 脊瓦
47,5 x 25 x 10,5 cm.
2,22 Units/ml / 4,00 kg.
Max. Slope. 60%-31°



低 100° 斜脊瓦頭
37 x 25 x 10,5 cm.
2,70 kg.



低 100° 三通瓦
40 x 45 x 22 cm.
5,15 kg.



低 100° 四通瓦
46,5 x 46,5 x 16 cm.
7,50 Kg.



低 100° 脊瓦頭
27,5 x 28 x 7 cm.
2,1 kg.



左右互鎖平行邊瓦
FLAT-5XL® 專用
47,5 x 15,5 x 8 cm.
2,85 kg.



左右互鎖平行邊瓦
45,5 x 8 x 15 cm.
2,20 kg.



左右互鎖平行邊瓦
47,5 x 15,5 x 11,5 cm.
3,15 kg.



直角邊瓦
平板系列 (左邊/右邊)
40,4 x 12,4 x 12,4 / 2,6 cm.
3 Units/ml / 2,50 kg.



共用邊瓦
43 x 14,5 x 14,5 cm.
2,5 Units/ml / 2,85 kg.
(單斜亦適用)



透氣煙囪
24,5 Øext - 22 Øint x 6 cm.
1,70 kg.



140 煙囪
22,5 Øext - 20 Øint x 23,5 cm.
2,35 kg.



130 煙囪
20,4 Øext - 18 Øint x 23,5 cm.
2,15 kg.



高 100° 脊瓦
47,5 x 25,8 x 12,5 cm.
4,15 kg.
Max. Slope. 100%-45°



高 100° 斜脊瓦頭
37 x 25,8 x 12,5 cm.
3,3 kg.

FLAT-5XL®



FLAT-5XL®
煙囪座
45,7 x 27,2 x 16 cm.
3,5 kg.

FLAT-10Tech

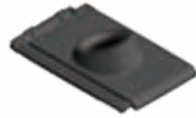

FLAT-10 Tech
煙囪座
47,5 x 28,9 x 10,5 cm.
3,5 kg.

TBAF-10



TBAF-10 煙囪座
47,3 x 26,22 x 10,2 cm.
3,4 kg.

TBAF-12



TBAF-12 煙囪座
43 x 25,5 x 12 / 15,5 Øext-13,5
Øint cm. - 4,00 kg.



TBAF-12 半瓦
43 x 15 x 4,5 cm.
1,25 Units/lm / 1,80 kg.



FLAT-5XL®
半瓦
45,7 x 27,2 x 2,4 cm.
3,5 kg.



FLAT-10 Tech 半瓦
47,5 x 16,6 x 2,6 cm.
2 kg.



TBAF-10 半瓦
47,3 x 15,31 x 2,6 cm.
2 kg.



TBAF-12 透氣瓦
43 x 25,5 x 9 cm.
3,70 kg.



130 煙囪
20,4 Øext-18 Øint x 23,5 cm.
2,15 kg.



FLAT-5XL®
透氣瓦
47,5 x 28,9 x 3,7 cm.
3,5 kg.



FLAT-10 Tech
透氣瓦
47,5 x 28,9 x 3,7 cm.
3,5 kg.

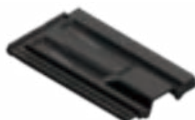

TBAF-10 透氣瓦
45,7 x 27,2 x 10,5 cm.
3,5 kg.



Ceramic 板岩系列

橘彩石



適用瓦型:

 FLAT-5XL®

 FLAT-10



NEW



Ceramic 板岩系列

雁灰(玄青岩)

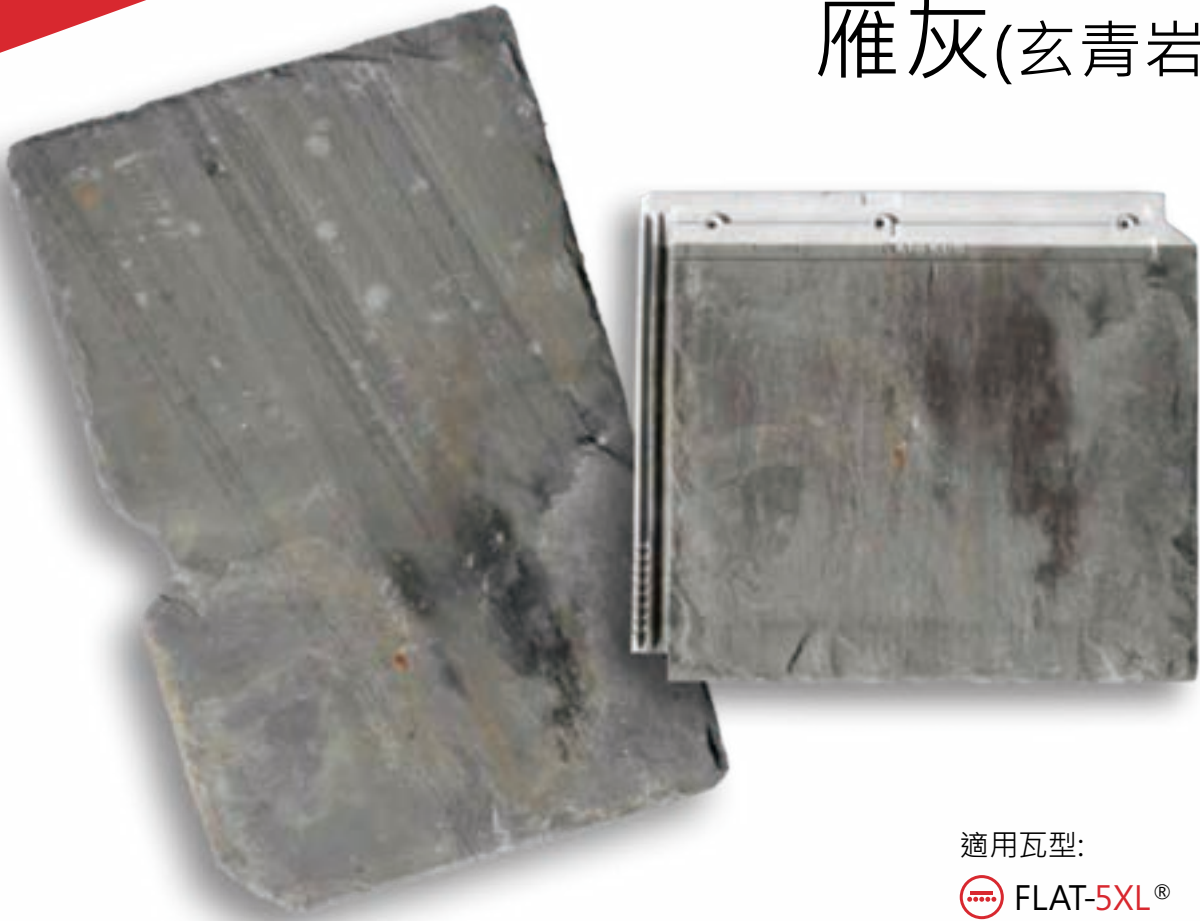

適用瓦型:

 FLAT-5XL®





Ceramic 板岩系列

金風石



適用瓦型:

 FLAT-5XL®

 FLAT-10





Ceramic 工業風系列

淡墨

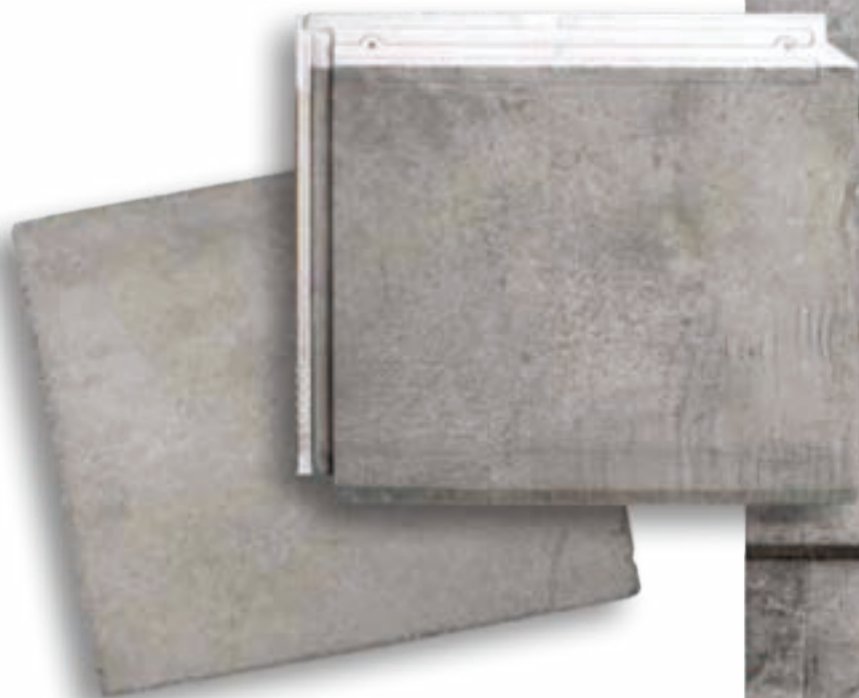

適用瓦型:

⊕ FLAT-5XL®

⊕ FLAT-10





Ceramic 古锈系列

古銅



適用瓦型:

 FLAT-5XL®

 FLAT-10





Ceramic 木紋系列

橡木紋



適用瓦型:

Ⓜ FLAT-10





Ceramic
彤岩



Ceramic
青灰石



Borja JET

Using this technological revolution we are able to make roof tiles with a wide variety of finishes such as slates, woods, stones, marbles and oxides. The result is a truly original product.



Ceramic
橘彩石



Ceramic
淡墨



Ceramic
橡木紋



Ceramic
黑金峰



Ceramic
古銅



FLAT-10Tech
硯石黑



TBAF-12
百年紅

Ideal for straight lines
roofs design, the at
tiles are timeless.

FLAT ROOFTILES



FLAT-10Tech
鐵灰



⊕ FLAT-10Tech
石墨黑



⊕ TBAF-12
金穗



⊕ TBAF-12
百年紅, 楓丹, 丹影



⊕ TBAF-12
百年紅, 楓丹, 丹影



單色系列

FLAT-10

鐵灰



FLAT-10

鐵灰

FLAT-10

硯石黑





單色系列

FLAT-10

硯石黑





S-INTERLOCKING 羅馬瓦系列





S-INTERLOCKING 羅馬瓦系列



Ⓜ TB-10 Tech

大型陶瓦的生產技術再進化，左右呈S型互扣的瓦型就是最典型的西班牙瓦。如今博哈呈現更逼真的仿舊色彩，唯美登場。



Ⓜ TB-12[®]

TB-12採小片樣式，讓屋頂更具豐富的線條感，適合各種大小的屋頂。由於上下左右互鎖設計，兼具美學與安全性，廣受世界各地使用者的喜愛。



Ⓜ TB-4[®]

羅馬瓦的亞洲型式，更豐富線條感，上下左右互鎖結構更嚴實，下寬上窄設計，在矩形或弧形的屋面都能產生優美的對齊線條。



Ⓜ TB-10 Tech

間距可依需要調整，適合各種屋型

直向、橫向雙重嵌入

絕美拱型曲線



> Klinker



系統化安裝



抗嚴峻高山氣候



上下交疊極小化
僅20mm

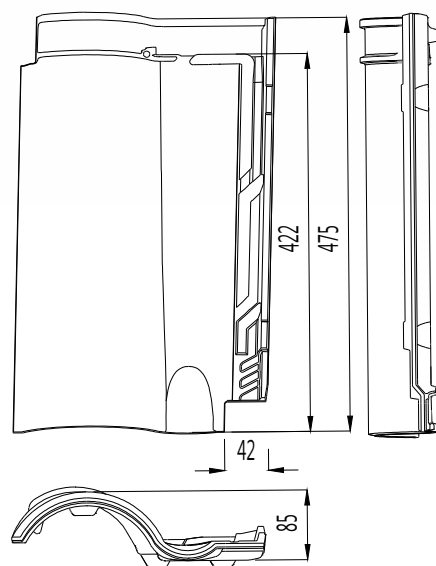

實際尺寸	475 mm x 282 mm
最低斜度建議	30% - 17° (*)
每片重量	3.45 Kg./片
平方公尺m ² /片	10.4 Units
橫向每米片數	4.25-4.54 片
有效寬度	235-220 mm
有效長度	390-410 mm
棧板包裝 T7 - 標準櫃 / T8 - 特殊櫃	(T7) 210 片 / 720 Kg. (T8) 140 片 / 480 Kg.
每捆片數	5 片





百年系列
松林



取自地中海地景風貌
採用獨家數位技術
如實將大自然的美感留在瓦片上

 TB-10 Tech



大地色系列

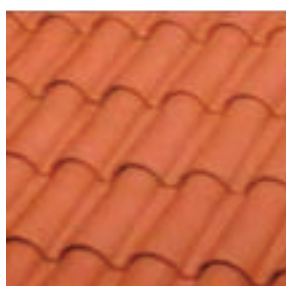

百年紅

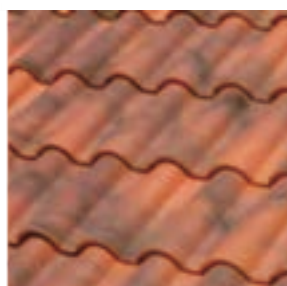

歲月紅

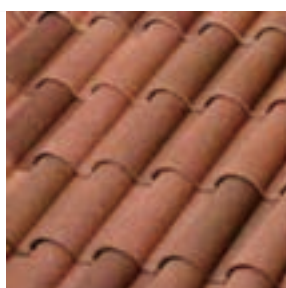

楓丹

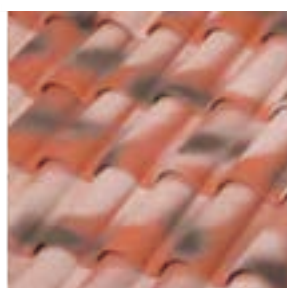

古舍

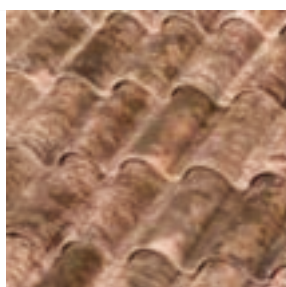

古堡

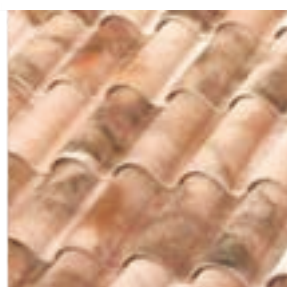

淡秋色

單色系列



咖啡

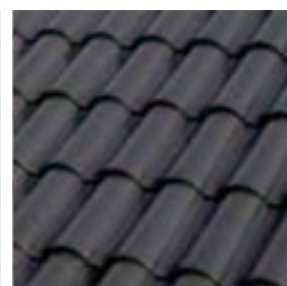

石墨黑

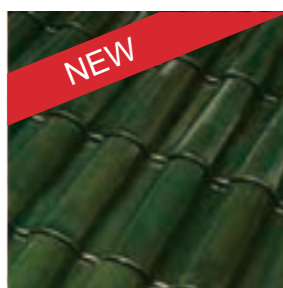

Glazed Green



Glazed Cobalt Blue

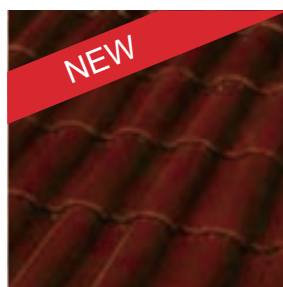

Glazed Cognac

百年系列



風華



秋原

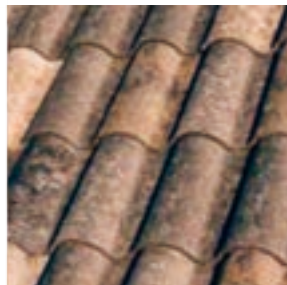

松林



高原紅

附註：
TB-10 Tech 百年系列表面均為仿天然紋路，所有 TB-10 Tech 產品均為單面上色。

An extremely safe roof tile with high resistance.
A small size S-interlocking roof tile format with
a wide range of finishes.



 TB-12[®]

直向橫向雙條互鎖卡榫設計，抗風能力更提昇
 高規格鎖水設計（釘孔在瓦片上方，防止雨水侵入）
 掛瓦條雙突檔，屋面穩定整平更精準



系統化安裝



最低斜度建議
30% - 16°



瓦片規格	
寬度	260 mm
長度	439 mm
重量	3.15 kg/片

安裝規範	
平方公尺 m ² /片	12.8 片
瓦條固定間距	370 mm





 TB-12®

TB_12®

百年系列



風華



春神

TB_12®
單色系列



石墨黑

TB_12®

大地色系列



百年紅

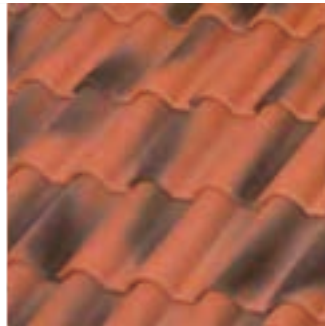

歲月紅



楓丹



古舍



山玫瑰



淡秋色



霞飛



夏艷



咖啡



鄉樸



大麥白



歲月白

Trade model of S-interlocking roof tile
adaptable to rounded areas with curved roof
tile aesthetic effect of 50 tiles per sq. m.

 TB-4[®]



一片瓦上呈現上下左右四片瓦的交疊視覺效果
 安全且鎖水性能佳 (釘孔在上方防雨水穿入)
 背面強化肋條，瓦片抗折力更高，結構更堅強
 背面上方雙瓦條突擋，讓屋面呈現整平流線



系統化安裝



最低斜度建議
30% - 16°



® TRADE MODEL



瓦片規格	
寬度	258 mm
長度	442 mm
重量	3,4 kg/片

安裝規範	
平方公尺 m2 / 片	12,8 片
瓦條固定間距	370 mm



 TB-4®

TB_4®

大地色系列

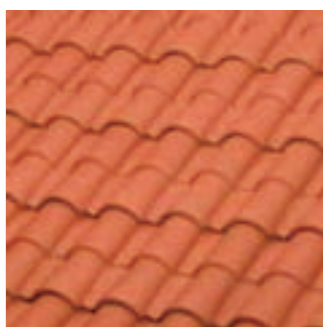

百年紅



秋色



C型瓦上窄下寬造型特別適用於圓錐型屋頂

Ⓞ C型瓦



精緻瓦片圓弧
造型修邊

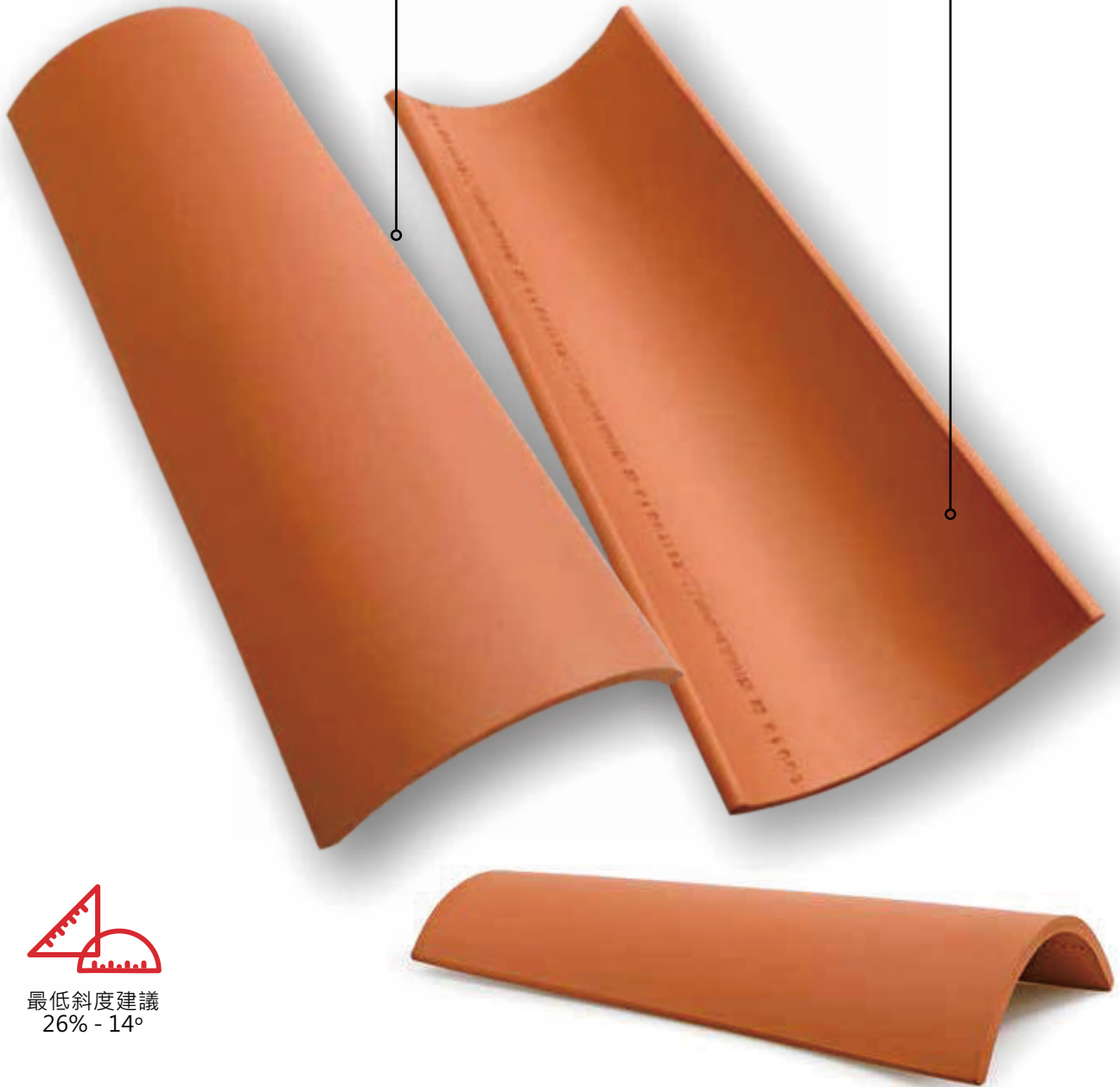

最低斜度建議
26% - 14°



C-50.21 Celler® 瓦片規格	
寬度	210/170 mm
長度	500 mm
重量	2,4 kg/片
平方公尺 m2 /片	18 片

C-40.19 瓦片規格	
寬度	180/140 mm
長度	408 mm
重量	1,6 kg/片
平方公尺 m2 /片	30 片



C-45.20 瓦片規格	
寬度	200/160 mm
長度	450 mm
重量	1,95 kg/片
平方公尺 m2 /片	25 片

C-40.15 瓦片規格	
寬度	150/116 mm
長度	408 mm
重量	1,35 kg/片
平方公尺 m2 /片	12 片



An aerial, high-angle photograph of a roof covered in multi-colored tiles. The tiles are arranged in a regular, overlapping pattern and feature a variety of colors including shades of red, orange, yellow, and grey. The roof is bordered by a dark gutter on the left side. In the bottom left corner, a patch of green grass is visible. A red banner with white text is overlaid at the bottom of the image.

© C-50.21 Celler® / C-45.20



百年紅



楓丹



古舍



風華



鄉樸



古堡



淡秋色



春神



咖啡



黎明



大麥白



秋原



百年紅



歲月紅



© C-25.12 / TB-ES

Decorative roof tiles.
Ideal for small roof areas.

C-25.12

大地色系列

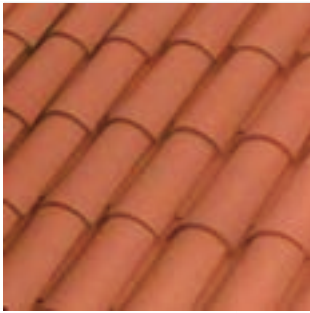

百年紅



鄉樸



大麥白



歲月白

TB-ES



百年紅

TB-ES

配件



"Gallon" Ridge
25 x 17,5 x 9,7 cm.
4,5 Units/lm / 0,75 Kg.



"Gallon" Ridge with Ball
25 x 17,5 x 13 / 4,5 cm.
Units/lm / 0,85 Kg.



Winged Dragon End Ridge
40 x 15 x 16 cm.
1,95 Kg.



Achantus Leaf End Ridge
32 x 15 x 26,5 cm.
2,19 Kg.



C-25.12 瓦片規格

寬度	120/95 mm
長度	250 mm
重量	0,65 kg/片
平方公尺m ² /片	70 片



TB-ES 瓦片規格

寬度	150 mm
長度	195 mm
重量	0,40 kg/片
平方公尺m ² /片	78 片





琉璃系列

TB-12® / TB-4® / ALICANTINA-12 / CURVED Roof Tiles / TB-ES

GLAZED

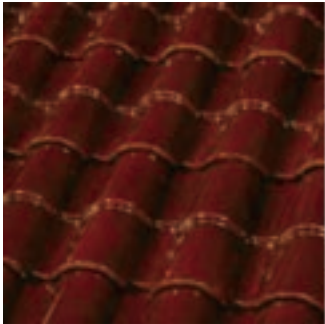

Cognac



Green



Cobalt Blue



Carmin



White

TAMIZADOS



Slate



Grey



Green

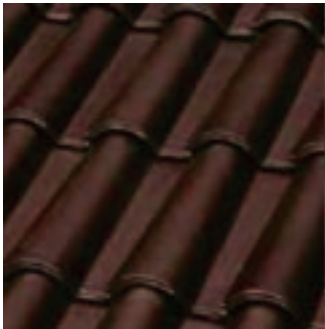

Brown



Blue



Borja DECOR

This line of roof tiles combines exclusive finishes and unbeatable visual sensations in a roof.

Iridescent colours for homes with its own personality which confer a unique look.

琉璃系列

CRYSTAL



Crystal Reds



Elegant®

METALLICS



Copper



Lead

TB-4®

IRISADOS



Cognac



Green

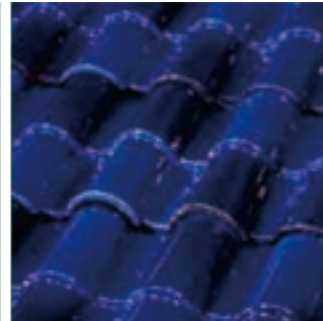

Blue

INSPIRATION



Ocre



Indigo



Lienzo de Mar



S-INTERLOCKING 羅馬瓦系列

配件

M型脊瓦 43 x 23 x 9 / 2,50 cm. Units/lm / 2,50 Kg. Max. Slope 47%-25.10°	M型斜脊瓦頭-貝殼 43 x 20 x 8,5 cm. 2,95 Kg.	M型三通瓦 37,5 x 23 x 9,5 cm. 4,20 Kg.	M型四通瓦 38,5 x 44,5 x 13,5 cm. 4,50 Kg.	M型脊瓦頭-三角 7,5 x 24,5 x 27,9 cm. 2,40 Kg.	M型脊瓦頭-鳥嘴 17,5 x 26,7 x 27 cm. 2,80 Kg.
C型脊瓦 44,5 x 28,5 x 10,5 cm. 2,50 Units/lm / 3,50 Kg. Max. Slope 47%-25.10°	C型斜脊瓦頭 43,5 x 23 x 8,5 cm. 3,20 Kg.	C型三通瓦 32,5 x 42,5 x 14,5 cm. 3,10 Kg.	C型四通瓦 40,5 x 40,5 x 14 cm. 4,00 Kg.	C型脊瓦頭-三角 6,5 x 27 x 31 cm. 2,00 Kg.	C型脊瓦頭-鳥嘴 14,7 x 27,5 x 29,5 cm. 2,25 Kg.
脊瓦擋 24 x 12,2 x 5,6 cm. 5,00 Units/lm (on monopitch) 0,80 Kg.	直角邊瓦 (左邊/右邊) 47 x 9 x 17 cm. 2,50 Units/lm 3,00 Kg.	圓角邊瓦 (左邊/右邊) 47 x 18,7 x 16 cm. 2,50 Units/lm / 3,25 Kg.	共用邊瓦 (單斜亦適用) 43 x 14,5 x 14,5 cm. 2,50 Units/lm / 3,00 Kg.	130 煙囪 20,4 Øext-18 Øint x 23,5 cm. 2,15 Kg.	透氣煙囪 24,5 Øext-22 Øint x 6 cm. 1,70 Kg.



共用鳥止
TB4/TB12/C40.19
13,8 x 7,1 x 6,8 cm.
5 Units/lm / 0,60 Kg.

TB_12®

TB_4®

TB_10 Tech

TB-12° 半瓦 44 x 16 x 6,5 cm. 2,50 Units/lm 1,80 Kg.	TB-12° 雙主瓦 43,6 x 36 x 7 cm. 2,50 Units/lm 4,50 Kg.	TB-4° 專用邊瓦 (左邊/右邊) 43 x 13,5 x 14 cm. 2,50 Units/lm / 2,55 Kg.	TB-4° 半瓦 44 x 15,5 x 6 cm. 2,5 Units/lm // 1,83 Kg.		
TB-10 Tech 半瓦 Roof Tile 47,4 x 18 x 7,5 cm. 2,2 Kg.	TB-10 Tech 雙主瓦 47,4 x 41 x 7,5 cm. 5,2 Kg.	TB-12° 2/3半瓦 30,5 x 26,5 x 7 cm. 5,00 Units/lm 2,20 Kg.	2/3雙筒瓦 TB-12° 專用 30 x 36,2 x 7 cm. 3,24 Kg.	TB-4° 半瓦 25 x 26 x 6 cm. 5 Units/lm / 2,30 Kg.	TB-4° 透氣瓦 43,5 x 26 x 10 cm. 3,50 Kg.
TB-10 Tech 通風瓦 47,4 x 28,2 x 7,5 cm. 3,6 Kg.	TB-10 Tech 煙囪座 47,4 x 28,2 x 18 cm. 6 Kg.	TB-12° 通風瓦 44 x 26 x 7 cm. 3,20 Kg.	TB-12° 煙囪座 43,5 x 25,5 x 11 cm. 16 Øext-13 Øint / 4,15 Kg.	TB-4° 煙囪座 43,5 x 26 x 18 cm. 16 Øext-13 Øint / 4 Kg.	TB-4° 筒瓦 DecoCurved® 25 x 16 x 5,5 cm. 5 Units/lm / 1 Kg.
140 煙囪 22,5 Øext-20 Øint x 23,5 cm. 2,35 Kg.	TB-12° 筒瓦 37 x 17 x 7 cm. 5,00 Units/lm / 2,00 Kg.	TB-12° 底瓦 47 x 16 x 7 cm. 5,00 Units/lm / 2,50 Kg.	TB-4° 底瓦 46 x 16 x 6 cm. 5,00 Units/lm / 2,60 Kg.		



☺ TB-12®
霞飛



☺ TB-12®
咖啡

S-interlocking roof tiles are easy to fit and versatile, adaptable to any type of project. Always offering the best results in every building.

S-INTERLOCKING 羅馬瓦系列



☺ TB-10 Tech
楓丹



Ⓜ TB-10 Tech
Entrepins



Ⓜ TB-12®
石墨黑



Ⓜ TB-4®
秋色



Ⓜ TB-10 Tech
風華



☺ TB-12®
霞飛



☺ TB-12®
夏艷

A wide range of finishings make possible to create roofs in harmony with the environment.

S-INTERLOCKING 羅馬瓦系列



☺ TB-12®
咖啡



☺ TB-12®
霞飛



☺ TB-10 Tech
® 風華

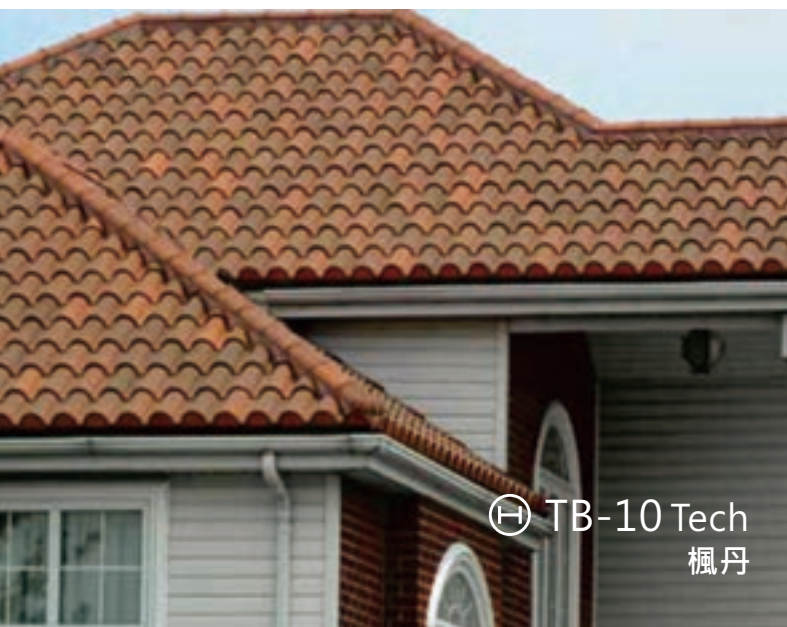

☺ TB-10 Tech
楓丹

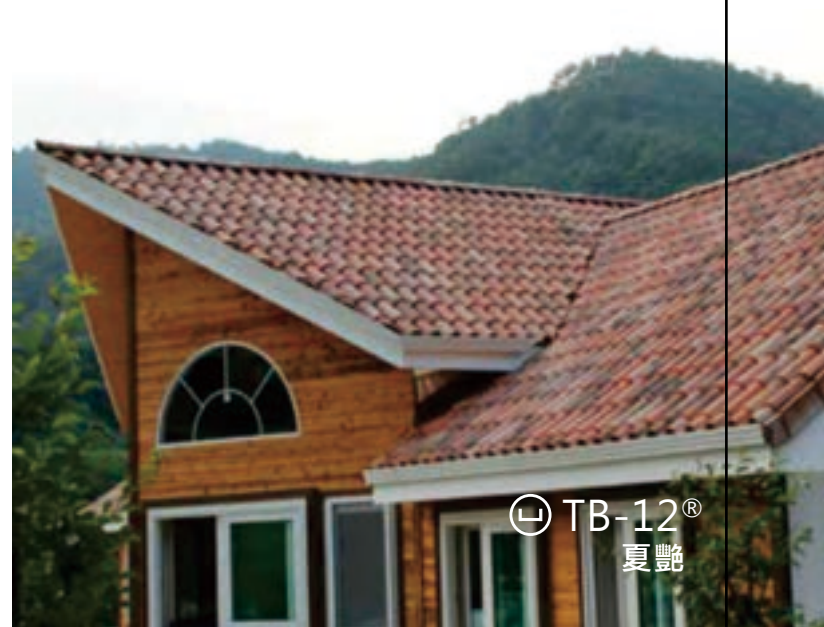

☺ TB-12®
夏艷



☺ TB-4®
秋色

屋瓦安裝配件

防水配件



高性能伸縮寬版防水膠帶



伸縮防水鋁膠帶



直立壁面防水板

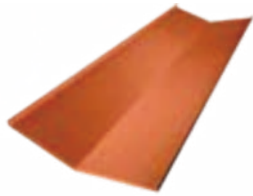

天溝鋁底板



寬版丁基自黏防水膠帶



掛瓦條



鍍鋅掛瓦條
30x30



鍍鋅通風排水掛瓦條
30x20



屋瓦安裝配件

透氣防水毯配件



高性能抗UV防水透氣毯
TB 180 加厚型



抗UV防水透氣毯
TB 160 標準型

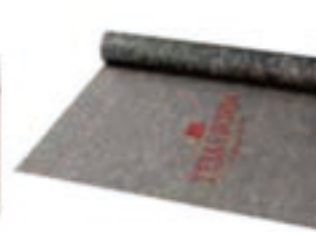

抗UV防水透氣毯
TB 130 輕量型



水氣阻隔毯



鋁皮瀝青復合防水毯



螺絲防水膠帶



多用途屋頂專用防水膠帶
50 mm

屋頂板材



水泥纖維板
(C-45,C-50專用)



合成樹脂板
(羅馬瓦系列專用)



合成樹脂板
(C-45,C-50專用)

屋脊透氣防水毯



屋脊複合式膠帶



屋脊鋁膠帶

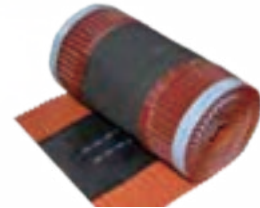

屋脊防水通風毯



屋瓦安裝配件

固定配件



陶瓦專用膠



脊瓦八字夾



防風夾



脊瓦固定器



雪止器



不鏽鋼自攻螺絲釘

簷口通風配件



塑膠通風鳥止器 100 mm

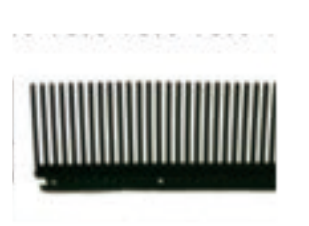

塑膠通風鳥止器 60 mm

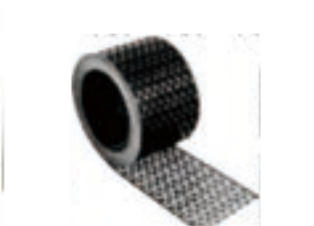

金屬通風鳥止器 80 mm



塑膠二合一通風鳥止器
(瓦條 30 mm; 鳥止 60 mm)



油漆



陶瓦專用漆

BORJATHERM®

Thermal insulated roofing SYSTEM

博哈六合一適能板

屋頂斷熱材



任何屋頂結構均適用

BORJASYSTEM

博哈屋頂系統-高效率通風組合



防水系統



固定系統



通風系統



Taiwan Exclusive Representative
Countryland Enterprise Co., LTD.
www.countryland.com.tw

堯鑫瓦業有限公司

Tel.04-2338-4589

Fax.04-2338-0295

www.yaosin4589.com.tw

台中市烏日區學田路419號